

GAUGING
YOUR
KNITS

I N T E R W E A V E
KNITS

SUMMER 2005

summer
knitting
27 breezy
projects

Teva Durham
knitting on the edge



Check under the hood for the original Fun Fur.



Don't get hoodwinked. Ask for the original, Lion Brand Fun Fur. No other fur yarn can match the quality, plushness or colors of Lion Brand.

LION BRAND® YARN



FOR THIS FREE PATTERN AND
OVER 500 OTHERS, VISIT www.Lion-Brand.com

contents

SUMMER 2005, VOLUME X, NUMBER 2



36



40



38

projects & features

- 12 **One-Button Cardigan** *Mari Lynn Patrick*
Wrap yourself in the latest fashion.
- 18 **Isis Wrap** *Kathleen Power Johnson*
Knit a lacy cardigan named for an Egyptian goddess.
- 22 **Summer Sundress** *Mari Lynn Patrick*
A flirty dress that features lace panels and spaghetti straps.
- 28 **Bed and Bath Duo** *Micki Hair*
Pamper yourself in the quiet beauty of soft natural fibers.
- 36 **Two-Tie Striped Cardigan** *Susan Mills*
Stripes, ribs, and ties—this cardigan has it all.
- 40 **Viennese Shrug** *Lisa Daehlin*
Take a spin in a wrap that's as graceful as a waltz.
- 44 **Padded Footlets** *Mary Snyder*
These short socks are good for your soles.
- 48 **Great Gifts**
Four great projects—a lacy scarf, felted bag, sketchbook cover, and stretchy scarf—that are ideal for gift-giving (or keeping!).
- 58 **Acorn Camisole** *Shirley Paden*
The quintessential feminine top.
- 64 **Fiery Bolero** *Debbie Bliss*
A minimal top inspired by flamenco dancers.
- 68 **Premier Pullover** *Fiona Ellis*
Lace gives rise to cables that flow into more lace in a versatile pullover.
- 72 **Buffalo Girl Neck and Wrist Warmers** *Therese Chynoweth*
Great things happen when buffalo yarn meets Victorian lace.
- 76 **Profile: Teva Durham** *Julie Moline*
Meet an innovative knitwear designer who specializes in pushing the limits.

- 78 **Lace Leaf Pullover** *Teva Durham*
A Loop-d-Loop book excerpt.
- 80 **Fan Clutch and Fun Fur Collar** *Lisa Daehlin and Katy Ryan*
Dress up the night with a clever clutch and faux fur collar.
- 84 **Sleek Ribs Tank** *Therese Chynoweth*
Strategically placed increases and decreases give a fresh slant to a ribbed tank.
- 88 **Dylan Goes Electric** *Karen Baumer*
Knit a manly pullover that honors the reverberations of electric guitars.
- 92 **Shoulder Shrugs**
Another Knits staff project.
- 95 **Beyond the Basics: Got Gauge?** *Sandi Wiseheart*
There's a reason to knit those pesky swatches.
- 96 **Go with the Flow Socks** *Evelyn A. Clark*
Another great pair of socks from a veteran sock knitter.
- 98 **Baby Gifts**
Four more ways to pamper baby—tiny socks, aromatic heart sachet, garter-stitch kimono, and tiny teddy bears.

On the cover: Summer Sundress, page 22.

departments

- | | | | |
|-----|--------------|-----|--------------------|
| 2 | Strands | 106 | Oops! |
| 6 | News & Views | 119 | Advertisers' Index |
| 10 | Bookshelf | 120 | Ravelings |
| 104 | Glossary | | Lory Widmer Hess |

■ s t r a n d s



It's crazy. How does one write for a summer issue of *Interweave Knits* and *not* comment on the disconnect inherent in the publishing business? Because of the lag time between preparation and printing, we work on the warm-weather issue during the coldest time of year. And even though winter is nearing an end as we close this issue, today as I write, I'm looking out on a veritable wasteland of snow. I'd like to say that I can hear the steady drip of a dissolving icicle or that I can see wet patches on the road—signs that herald a thaw and the change of season. Alas, the scene outside is as still and frigid as any during the dead of January.

Earlier, as a palliative to the heartlessness of these straggling final days of winter and uninterrupted snowscape, I slogged my way to the local library to borrow an audiobook. Wandering through the building in search of the books on tape, I passed through the periodicals room. As I did, I noticed a young woman turned sideways in an overstuffed chair, legs comfortably slung over the arm. I had a vague impression of stylish short bangs and a pair of trendy 1950s glasses, a woman in her early twenties maybe, intent on reading a magazine.

And then I did a double take. She was reading the current copy of *Knits* (!) and spread out on the low table in front of her chair was a small pile of back copies, some open, some with covers showing—a year or so's worth of the magazine. The pages, as familiar to me as my family photo albums, seemed somehow out of place in this strange place.

I ambled on to find the audiobooks, somewhat dazzled to think that knitting has made such a comeback, has become so much a part of everyday life that a magazine devoted to the craft has a dedicated space, along with *Time* and *Better Homes and Gardens*, on this library's magazine shelves. Proof, in my estimation, that knitting, unlike the weather here in New Hampshire, has no season. Like all good craft, knitting contains such powers of rejuvenation that today's young women are turning to it for fun, for style, for inspiration.

Though the projects in this issue reflect current ideas on knitwear design, they also point to the timelessness of knitting's design elements. The classic zigzag cables in Karen Baumer's guy sweater, the simple ribbing in the neck-cupping collar on Debbie Bliss's little bolero, the delicate lace and texture stitches in Shirley Paden's elegant camisole—these are knitted motifs that can be combined and recombined to create new and imaginative garments.

In this issue, you'll learn about a maverick knitwear designer, Teva Durham, whose imaginative mining of the possibilities in knitting has helped to make the craft young again. And in our News & Views section, read about men who are unabashedly taking up needles and yarn as a means of self-expression and personal pleasure.

Difficult as it is for me to picture the warmth and color of the season in which you're reading this, today, as I look out on a monochromatic, glass-brittle landscape, I take heart in knitting's endless summer.

Pam Allen

Many thanks to Black Parrot, Rockland, Maine, for the non-knitted garments used in this issue.

Have a question about your *Interweave Knits* subscription? We have the answer. Visit our website, e-mail, call, or fax your question and we'll be happy to assist you.

Go to www.interweave.com and click on Subscription Services in the page footer for new subscriptions, renewals, gift orders, and to change your address, pay your bill, and to submit subscription questions or concerns.

Interweave Knits Subscription Services

E-mail Address:

www.interweaveknits@pcspublink.com

U.S. & Canadian Customer Service: (800) 835-6187

International Customer Service: (760) 291-1531

Fax Number: (760) 768-4805

Mail: PO Box 469117, Escondido, CA 92046-9117

INTERWEAVE KNITS

EDITORIAL

EDITOR-IN-CHIEF Pam Allen

SENIOR EDITOR Ann Budd

MANAGING EDITOR Sandi Wiseheart

CONTRIBUTING EDITORS Cyrene Slegona, Meema Spadola

TECHNICAL EDITORS Lori Gayle, Karen Frisa

COPY EDITOR Stephen Beal

EDITORIAL ASSISTANT Susan Sternlieb

CREATIVE SERVICES

ART DIRECTOR Leigh Radford

PRODUCTION MANAGER Trish Faubion

PRODUCTION COORDINATOR Mark Drobroth

PRODUCTION EDITOR Nancy Arndt

PHOTOGRAPHY Chris Hartlove (unless otherwise noted)

PHOTOSTYLING Mary Jane Mucklestone

ILLUSTRATION Gayle Ford

PUBLISHING

PUBLISHER Marilyn Murphy

DISPLAY ADVERTISING MANAGER Tiffany Zerges

SENIOR AD TRAFFIC MANAGER Rebecca Campbell

CLASSIFIED ADVERTISING Corina McClanahan

PROMOTIONS COORDINATOR Annie Hartman Bakken

WEB MARKETING MANAGER Bruce Hallmark

CIRCULATION DIRECTOR Trish Carter

SINGLE COPY SALES DIRECTOR Jenny Valentine

FULFILLMENT MANAGER Deborah Atchley

CONSUMER MARKETING MANAGER Barbara Naslund

Projects and information are for inspiration and personal use only. *Interweave Knits* does not recommend, approve, or endorse any of the advertisers, products, services or views advertised in *Knits*. Nor does *Knits* evaluate the advertisers' claims in any way. You should, therefore, use your own judgment in evaluating the advertisers, products, services, and views advertised in *Knits*.

Interweave Knits (ISSN 1088-3622) is published quarterly by Interweave Press, Inc., 201 E. Fourth St., Loveland, CO 80537-5655. (970) 669-7672. USPS #017-249. Periodicals postage paid at Loveland, CO 80538, and additional mailing offices. All contents of this issue of *Interweave Knits* are copyrighted by Interweave Press, Inc., 2005. All rights reserved. Projects and information are for inspiration and personal use only. Reproduction in whole or in part is prohibited, except by permission of the publisher. Subscription rate is \$26.95/one year in the U.S., \$30.95/one year in Canada, and \$33.95/one year in international countries (surface delivery) U.S. funds only.

POSTMASTER: Please send address changes to *Interweave Knits*, PO Box 469117, Escondido, CA 92046-9117.

SUBSCRIBERS: Please allow six weeks for processing address changes. Your customer number on the address label is your key to the best service possible. Please include it with all correspondence to avoid delays or errors.

Visit the Interweave Press website at www.interweave.com.

For advertising information, call Tiffany Zerges at (203) 937-7659, e-mail tiffanyzb@interweave.com or visit the website at www.interweave.com.

For sales information, call (800) 272-2193, e-mail sales@interweave.com.

For editorial inquiries, call (800) 272-2193, e-mail knits@interweave.com, or write to 201 E. Fourth Street, Loveland, CO 80537-5655.

 INTERWEAVE PRESS

Tahki Yarns



20 FUN TO KNIT DESIGNS

For Spring/
Summer 2005
Tahki Yarns presents
20 bright ideas in
Cotton Classic.
More than 150 colors
to choose from...

Ask for it at your favorite
yarn retailer or reserve
your copy today by sending
\$11.99 plus \$1.25 to:

Tahki • Stacy Charles, Inc.
70-30 80th Street,
Ridgewood, N.Y. 11385



THE KNITTING CONNECTION WEBSITE LISTINGS

Your Guide to Shopping on the Web

BOOKS

Interweave Knits
www.interweave.com/knit
(800) 272-2193

MAGAZINES

KnitNet
www.knitnet.com
KnitNet Magazine

MAIL ORDER

Catherine Knits
www.catherineknits.com
(718) 836-6439

Got Yarn
www.GotYarn.com
(888) 242-4474

Knit and Stitch = Bliss
www.knitandstitch.com
(866) 5NEEDLE

Yarnworld of the UK
www.yarnworld.co.uk
email: info@yarnworld.co.uk

NEW SHOP

Stitch Therapy
A Fine Yarn Shop
www.stitchtherapyparkslope.com
(718) 398-2020

PATTERNS

Dawn Brocco Knitwear Designs
www.dawnbrocco.com
email: dbdesign@ulster.net

SpinCraft Patterns
www.spincraftpatterns.com
(208) 756-3076

Y2Knit
www.y2knit.net
(301) 766-4543

SUPPLIES

Brittany Company
www.brittanyneedles.com

TRAVEL

Jean Moss Tours
www.jeanmoss.com
+44 (0) 1904 646282

Scottish Skeins & Skerries Tours
www.joycejamestours.com
(416) 928-6071

YARNS

Blue Heron Yarns
www.blueheronyarns.com
(410) 820-7471

Brown Sheep Company
www.brownsheep.com
(308) 635-2198

Busy Hands Yarn
www.busyhandsyarn.com
(613) 399-5446

Coats & Clark
www.coatsandclark.com

Hemp for Knitting
www.hempforknitting.com
(888) 301-0011

Lion Brand Yarn Co
www.lionbrand.com

Louet Sales
www.louet.com
(613) 925-4502

Muench Yarns
www.muenchyarns.com
info@muenchyarns.com

Plymouth Yarn Company
www.plymouthyarn.com
(215) 788-0459

Russi Sales
www.russisales.com
(800) 950-1078

Skacel Collection, Inc.
www.skacelknitting.com
(800) 255-1278

Tahki/Stacy Charles, Inc.
www.tahkistacycharles.com
(800) 338-YARN

Unique Kolours
www.uniquekolours.com
(800) 25-2DYE4

Yarns International
www.yarnsinternational.com
(800) YARNS-2U

WEBSITES TO VISIT

Arcadia Knitting
www.arcadiaknitting.com
(866) 595-7159

Colorful Stitches
www.colorful-stitches.com
(800) 413-6111

Common Threads
www.fiberartshop.com
(888) 234-9592

The Elegant Ewe
www.elegantewe.com
(603) 226-0066

Gail Knits
www.gailknits.com
(702) 838-7713

GreatKnittingYarns.com
www.greatknittingyarns.com
info@greatknittingyarns.com

Halcyon Yarn
www.halcyonyarn.com
(800) 341-0282

Kathy's Kreations
www.kathys-kreations.com
(724)238-9320

The Knitters' Mercantile
www.knittersmercantile.com
(614) 210-0767

Knitting Arts
www.GoKnit.com
(408) 867-5010

L'Atelier
www.latelier.com
(888) 528-3543

Patternworks
www.patternworks.com
(800) 438-5464

SpinBlessing
www.spinblessing.com
k2tog@spinblessing.com

stick to your knitting
www.styk.com.au
(612) 9629-5053

Woodland Woolworks
www.woolworks.com
(800) 547-3725

Yarn Expressions
www.yarnexpressions.com
(800) 283-8409

The Yarn Studio
www.yarnstudio.com
(901) 276-5442

Yarniverse
www.yarniverse.com
(901) 818-0940

Yarnware.com
www.yarnware.com
(877) 369-9276

YarnXpress.com
www.yarnxpress.com
info@yarnxpress.com

*For the work of your
hands, the fabric
of your life*

FOUNDER, CEO Linda Ligon
PRESIDENT, COO Marilyn Murphy
VICE PRESIDENT, SALES & MARKETING
Linda Stark
VICE PRESIDENT, OPERATIONS & FINANCE
Dee Lockwood
VICE PRESIDENT, HUMAN RESOURCES
Suzanne DeAtley

INTERWEAVE PRESS BOOKS

PUBLISHER
Linda Stark
EDITORIAL DIRECTOR
Betsy Armstrong
ON-LINE CONTENT MANAGER
Bruce Hallmark

For questions regarding our book program, call (970) 669-7672 (Monday-Friday, 8:00 A.M.-5:00 P.M., or e-mail books@interweave.com.

MAGAZINES

Beadwork
Fiberarts
Handwoven
Interweave Knits
PieceWork
Spin-Off
Natural Home & Garden,
a subsidiary of Interweave Press
Interweave Press, Inc.
201 East Fourth Street
Loveland, Colorado 80537
(970) 669-7672

Visit our website
www.interweave.com.

Fashion Yarns . . . Discover Them At Plymouth



JUNGLE

Luxurious printed nylon tape



Available at your local yarn shop or send
\$4.00 plus \$1.00 postage for collection S286-290-308 and names of shops in your area.



PLYMOUTH
YARN • COMPANY
P.O. Box 28 • Bristol, PA 19007
www.plymouthyarn.com

Leaping Tall Buildings with a Single Cast-On

by Bethany Lyttle

What do comic-book superheroes—Batman and Spider-Man, for instance—have to do with knitting? Nothing, according to Mark Newport—and that’s precisely the point. Knitting, often dismissed as “women’s work,” is the last thing one associates with comic-book superhero figures who epitomize male power and bravado. But Newport, a fine artist and professor of fiber arts at Arizona State University, is attempting to unravel these stereotypes—one stitch at a time.

The concept for the hand-knitted superhero costumes evolved over several years. “Sometime in the mid-1990s, I started to play around with ways in which men and women are depicted in popular culture,” explains Newport. “I started to embroider the pages of comic books, then to incorporate these embellished pages into paper quilts.” Suddenly the superhero images—“protective” male heroes—had been transformed into the kind of “protection” a traditional mother or grandmother might offer: the warmth and comfort of a quilt.

The birth of his two children further fired Newport’s fascination with images of man-as-protector. “It became clear very early on that my kids viewed me as capable of anything. I wanted that to be true! But it isn’t—and it shouldn’t be. A superhero may be the image of the ultimate protector—but believe me, as someone who read a lot of Batman comics as a kid, I can tell you this: The comics never taught me anything about how to be a dad.”

Aiming to illustrate how little substance there is to comic-book notions of heroic protection, Newport set out to knit the costumes of his favorite boyhood superheroes. In doing so, he hoped to demonstrate the lifelessness of their forms. After all, a Batman suit without the man inside is nothing but a lifeless costume, limp as a deflated balloon.

Not that Newport remembered how to knit. He didn’t. “It’s true that I was taught

as a kid. My brother and I would visit my grandmother, who lived alone. You have to know that when it came to knitting potholders and headbands, we were given complete instruction. But the minute I walked away, I promptly forgot everything my grandmother showed me.” So Newport



Left: Spiderman; right: Batman; both lifesize and worked in acrylic. Greg Kucera Gallery, Seattle, Washington.

turned to his wife for help, and she suggested that he consult a beginner’s knitting book.

Thus he began. “First I found instructions for knitting a raglan sweater from the top down. Once I realized that the whole sweater was essentially a big tube, I just kept going. I knitted beyond what would have been the waistline, then split the knitting into two more tubes for legs. The hardest part was getting the eyeholes for the masks in the right place.”

All the costumes are knitted from acrylic yarn, which Newport deems fitting in light of his personal history (“My mother believed nothing should require ironing.”) and because it’s virtually indestructible

(“If acrylic isn’t protective, what is?”). His first costume project was Batman, whom Newport calls his “patron saint superhero.” From there, he worked up Spider-Man and the Fantastic Four, among others. It takes him roughly two months to make each costume.

Currently, Newport’s at work on a new set of costumes—a series called Sweatermen. Knitted from synthetics in a variety of different patterns and textures, including cables, the costumes pay homage to the sweaters made for him by his grandmother—a woman whose role as protector was very authentic, says Newport.

Does he really hope to effect social change through knitting? “Of course,” says Newport, “but I have to admit that having small kids has certainly challenged that idea.” Having spent most of his career creating work that would be a meaningful contribution to important discussions—to feminism, to considerations of how children should be raised—he’s rethinking some of his old ideas about gender and childrearing. “As a dad I’ve observed that, to a very real extent, kids seem to be born with very specific ideas about what it is to be male or female. A perfect case in point is our eldest, our daughter, who has been raised in a truly gender-neutral family. When she was little, we’d go shopping, and she’d immediately make a beeline to the pinkest, most frilly thing in the store. And my son, who is now four years old, recently announced that when he grows up he’s going to be ‘a muscle man and wrestle me up some girls.’ What does that mean? His mother and I have no idea—and we hope he doesn’t either!”

BETHANY LYTTLE lives in Brooklyn, New York. To date, more than 350 Brooklynites have learned to knit in her living room.

More Knits!

The *Interweave Knits* website has even more pages of *Knits* for you—information and patterns that we couldn't fit into these pages. If you're forever trying to sort out a mess of circular needles or searching for that pesky fourth dpn, then you'll want to check out our reviews of several different types of knitting needle cases—hopefully one of them will get you organized! In addition, as a companion to the article on Sheila's Shawls (see page



9), we have compiled a list of online resources for knitted shawl patterns and supplies. And if you'd like to get going on a lovely little capelet, you'll find one designed by Amanda Blair Brown that's sure to please.

www.interweave.com

Knitted Artifact



V&A Images, Victoria & Albert Museum

Baby's gown, handknit, cotton thread; made by Sarah Ann Cuncliffe; English (Saffron Walden), 1851.

Sarah Ann Cuncliffe of Cambridgeshire, England, knitted this lace baby gown for the Great Exhibition of 1851, where it received third prize in the handknitting section. The little dress consumed 6,000 yards of cotton, and Sarah reportedly worked seven hours a day for five months to complete the estimated 1.5 million stitches. The leaf and diamond stitch patterns in the skirt, and the scallops that edge the hem, neck, and armholes, are similar to those used in Shetland lace shawls of the Victorian period.

—Deborah Pulliam

MAN ENOUGH TO KNIT STRONG ENOUGH TO PURL

of knitting resources and outright support for guys who knit. In October 2004, he launched the website menknit.net as a way to encourage more community among male knitters. Initially, response was mild—about a thousand hits in the first three months. Then in January 2005, an Associated Press article about the website ran in over 100 newspapers in the United States and the United Kingdom. The response to the article was immediate—menknit.net got 25,000 hits in three days. Vera had touched a vein.

“The site is a major labor of love and not about promoting anything other than a community for men who knit. Guys come online and share their knitting experiences—how they learned to knit and what it's like when they bring out their

Dan Vera learned to knit less than a year ago, but he didn't let being a novice knitter discourage him from becoming a leader among knitters—knitters who happen to be men. As an active member of a Washington, D. C., men's knitting group, Vera understands the lack

of projects in public. We've had some great stories. There's the motorcycle enthusiast from down South who knits in his local motorcycle shop. There's the man who learned to knit from his Ukrainian grandmother as a child. There are the recent new knitters who've gotten into knitting after visiting a yarn shop and have since become fiber freaks. They all seem very grateful to have a place to share their experiences and their wisdom about knitting.”

Vera hopes that the site will stimulate more community-building among guy knitters. In his experience, a man who brings out his knitting in public is still an anomaly. “I look forward to the day when a guy knitting doesn't turn so many heads—when a guy with a knitting bag looks just as normal as a guy with a sports bag. Hopefully menknit.net is a step in that direction.”

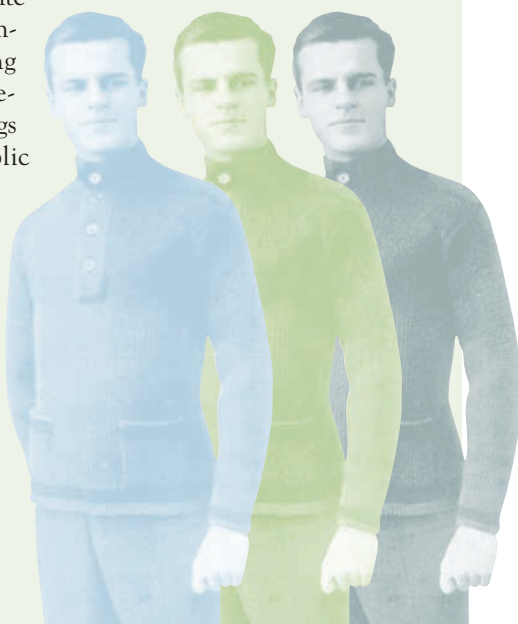

Knitting & Fine Art

In *Quest*, by the American artist William Sargeant Kendall (1869–1938), a knitted sweater is featured for the sake of its texture and pattern. Kendall must have spent hours with his chisel carefully replicating the knitted details—the columns of rib stitches, the panels of cables, and the knit-and-purl patterns—that emboss the sweater worn by this sculpted woman. From 1888

through early 1892, he studied both painting and sculpture in Europe, primarily in France. Like many artists, he left Paris during the summer for art colonies in the countryside. Kendall chose to visit Concarneau and Le Pouldu in Brittany, in the westernmost part of France. There, far from the hustle of urban life, he was one of many artists inspired by the life of the peasants, which he viewed as simple and sincere.

Kendall's sculpture is 34 inches high. The relatively large size and the warm color of the wood make the work startlingly lifelike. Yet the woman's hands—disproportionately large, very strong—are at odds with the rest of the piece. The emphasis on her hands points to the hard labor characteristic of peasant life. She isn't depicted at work, however, but at rest. Her far-away gaze suggests the spirituality Kendall found so prevalent among the Bretons, one reflected in the *Quest* title. Kendall's sculpture is meant as an homage to the hardworking, religious people of western France, and the careful carving of the woman's sweater—with its wide, square neck, loose fit, and distinct patterns—along with the woman's striking hands, can be seen as an homage to the folk art of knitting.

—Fronia E. Wissman



William Sargeant Kendall (1869–1938). *Quest*. 1910. Wood, polychromed; wood pedestal. 34 × 14½ × 17 in. Pennsylvania Academy of the Fine Arts. Gift of Mrs. William Sargeant Kendall, 1956.8.

Debbie Bliss's Loyalty Club

Designer **Debbie Bliss**, as passionate about her “fabulous” customers as she is about her knitting, has recently launched a Loyalty Club. Members will receive a welcome gift—a kit containing enough Debbie Bliss alpaca/silk to make the beret and cravat shown in the photo at right. Members will also receive four patterns a year that have been designed exclusively for club members, plus one or two preview patterns from upcoming books; a copy of a Spring or Autumn pattern book; and a quarterly newsletter highlighting new yarns, and color and fashion trends. In addition, there will be an online discussion board where members can post questions and tips. The cost of the club is £28 per year (which is about \$50, depending on the current exchange rate). For more information, check out the Club's website, <http://www.debbieblissonline.com/theclub/findoutmore.htm>.



web watch

Amy R. Singer
Editor, *Knitty.com*



photo courtesy of Amy Singer

Where ARE all the new knitting books coming from?

According to Amazon.com, forty-three knitting books were published in 1999. In 2004, 143. Where are publishers finding so many new authors? In a word: on the internet.

In my first column for *Interweave Knits*, I wrote about knitting blogs—a blog being a journal/diary/scrapbook that's posted on the web and usually updated daily. In general, bloggers (those who write a blog) are making news by reporting onsite from events like the Democratic and Republican national conventions and the war in Iraq. So the blog has clearly proven its worth as a handy information-spreading medium. But what else is it good for?

A blog is intended for public consumption. That means a blog writer gains experience in writing for an audience. Unlike conventional authors, blog writers get instant feedback from their audience. If they're boring, their daily visitor tally goes down. If they're contentious, readers can yell back at them. This kind of instant feedback can help turn an average writer into someone worth reading every day.

So it's not surprising that several authors of the newest crop of knitting books are also the authors of some of the best knitting blogs.

Meet one: Stephanie Pearl-McPhee, self-proclaimed Yarn Harlot, is a proud Canadian blogger who knits stuff that makes others weep with envy. Occasionally, she makes herself weep and then blogs about it, like the time she meticulously knitted two identical Latvian mittens—so identical they're both for the right hand. Her blog (www.yarnharlot.ca) isn't about how great Stephanie is, it's about how great knitting is. She recently announced to her blog-reading audience that her first book of essays will be published this spring by Storey: *At Knit's End: Meditations for Women Who Knit Too Much*. And her second book is due out this fall.

There are many more knitting bloggers who have books coming out in the next year or so. I'll introduce you to their backgrounds and their upcoming releases on the *Knits* blog: <http://blogs.interweave.com/knits>.

Sheila's Shawls— Knitting For a Safer World

by Betty Christiansen

It wasn't your everyday fashion show. No pouting waifs stalked the catwalks sporting impossible-to-wear constructions. Instead, the featured *haute couture* at this event was shawls: delicate lace shawls, humble comfort shawls, shawls honoring countries across the globe, shawls named for brave women like Harriet Tubman and Susan B. Anthony. All were glorious and handmade, and all were wrapped around models of varied ages, shapes, and sizes who twirled across the stage in a high-spirited celebration of creativity and social action. Yet for all its festive overlay, the Sheila Shawl Extravaganza, held at the University of Minnesota in June 2004, had at its center a sobering impetus: the ongoing fight against domestic violence and the memory of one of its foremost crusaders, the late Sheila Wellstone.

On October 25, 2002, Sheila Wellstone, champion for domestic violence awareness, was killed in a plane crash, along with her husband, Minnesota Senator Paul Wellstone. For many, it was impossible to fathom that these two tireless advocates for public well-being were gone.

Janet Hagberg, a friend of Sheila Wellstone and fellow domestic-violence activist, soothed her feelings of loss by wrapping herself in a prayer shawl she'd knitted as part of the Shawl Ministry program—a Connecticut-based movement through which shawls are handknitted and distributed to anyone in need of comfort. Enveloped in her shawl, Janet felt a gentle, reassuring presence. "It was as if Sheila was in the room with me," she remembers. "I thought if wearing this shawl can give me this much comfort, what might it do for another woman mourning the loss of a friend or relative who's been a casualty of domestic violence?"

As cofounder and director of the Silent Witness National Initiative, a Minneapolis-based center for domestic violence prevention, Janet knows the statistics well: Each day in the United States, an average of three women are killed by their husbands or boyfriends (though that number, she's happy to report, is on the decline). Through Silent Witness, Janet and others work to promote research on domestic violence and to raise awareness of the issue, chiefly through displays of life-sized red wooden cutouts in the outline of a woman's body. Each cutout bears a breastplate telling the name and story of a woman murdered by a husband or loved one. These displays have appeared in exhibits in every state and in seventeen other countries.

Janet's prayer shawl, and the enduring efforts of Sheila Wellstone, gave Janet a new idea for reaching out. Operating in much the same manner as the Shawl Ministry program, and with permission to use their basic shawl pattern, Janet began coordinating the knitting and distribution of Sheila's Shawls to anyone affected by domestic violence. The simple shawls are knitted and donated by vol-

unteers around the country, then shipped to several regional Silent Witness distribution centers. To date, more than 300 shawls have been given to friends, or relatives, of women murdered by violent partners. "The shawls," says Janet, "are a way to use the beauty of women's handwork to bring comfort to women in dire situations."

The Sheila Shawl Extravaganza—the buoyant fashion show and fund-raiser at the University of Minnesota—was a high-profile extension of this quiet movement. In the months leading up to the event, seventy-five shawls were designed and created by talented knitters, crocheters, and weavers (Janet knitted two of them herself) and exhibited at the university's Goldstein Museum of Design. "I wanted this to be a statement that would be seen and felt—not just heard as a statistic," says Janet.

In auction, the exhibited shawls raised more than \$40,000 to endow a Sheila Wellstone fellowship in the University of Minnesota School of Social Work; the fellowship is earmarked for students pursuing studies in the prevention of domestic violence. Fittingly, the shawl that caught the eye of the highest bidder was "Sheila's Shawl," one knitted by Marcia Avner, a close friend of Sheila. Worked in sections of mauve, purple, and moss green—the colors of Sheila's favorite dress—the soft woolen shawl reflects the warm and wonderful person Marcia remembers Sheila Wellstone to have been.

For more information on becoming involved with Sheila's Shawls, and to find patterns for knitting them, visit www.silentwitness.net.

From left: Harriet Tubman's Legacy, knitted by Brian Jones; Nautilus, knitted by Kathleen Martin; Sheila's Shawl, knitted by Marcia Avner. Above: Caribbean Charisma, knitted by Andy Gilats.



photos this page Petronella Yisma

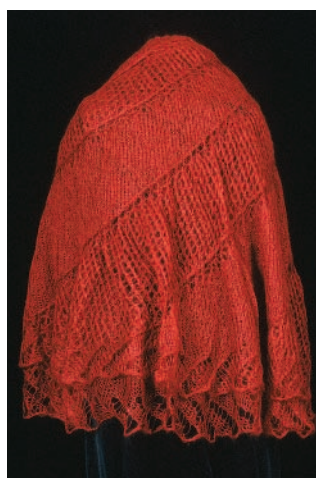

BETTY CHRISTIANSEN lives and writes about knitting in southeastern Minnesota, where one can never knit too many sweaters.

relax, handknit, create



Cannes from **The Beach Cool Collection**

For your local stockist contact:

UK: Rowan Tel 01484 681881 Email: mail@knitrowan.com

USA: Rowan USA Tel (603) 886 5041 Email: rowan@westminsterfibers.com

CANADA: Diamond Yarn Tel (416) 736 6111 Email: diamond@diamondyarn.com

AUSTRALIA: Australian Country Spinners Tel: 3 9380 3888

Email: sales@auspinner.com.au

bookshelf

All books available at book and yarn stores nationwide.

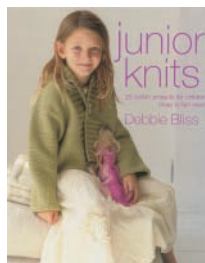

Junior Knits: 25 Stylish Projects for Children Three to Ten Years

Debbie Bliss (Trafalgar Square)

Junior Knits, the newest collection from talented knitwear designer Debbie Bliss, contains sweaters, hats, and jackets sure to please the pickiest of youngsters from ages three to ten (and their moms!). Accompanied by beautiful photographs and clear instructions, the collection offers modern garments with plenty of ease for comfort.

One-piece construction, basic stitches, and easy shaping make many of the projects perfect for the beginning knitter. ISBN 1-57076-300-3, \$24.95, 128 pages, spiral-bound.

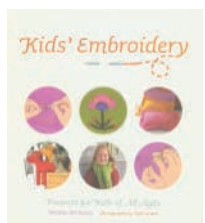

Kids' Embroidery: Projects for Kids of All Ages

Kristin Nicholas, with photographs by John Gruen (Stewart, Tabori & Chang)

This charming, colorful book by the well-known knitwear designer Kristin Nicholas presents the basics of needlepoint, cross-stitch, and freeform embroidery in a whimsical, modern format. How-

to illustrations that clearly demonstrate each stitch are handpainted by Nicholas herself, and Gruen's photographs show kids "just like me" happily stitching away on the simple, engaging projects that fill each chapter. Sidebars give young stitchers information on crafty activities such as hosting a stitching party and embellishing blue jeans. Although written for children, *Kids' Embroidery* is a fine introduction to the stitching arts for people of all ages. ISBN 1-58479-366-X, \$19.95, 144 pages, hardbound. See page 48 for Kristin's embroidered felted bag.



Knit Scarves! 16 Cool Patterns to Keep You Warm

Candi Jensen (Storey)

There are few knitting projects as easy and as satisfying as a scarf, and today's scrumptious yarns make scarves more popular than ever. Candi Jensen cooks up sixteen different ways to wrap yourself in warmth, complete with easy instructions and lots of handy tips. Beginners will feel right at home here,

with projects that start out simple and fast; advanced knitters will find new ideas and patterns to add to their scarf repertoire. From garter stitch to intarsia, cables to stripes, lace to fun fur, Jensen serves up a stylish buffet for all to enjoy. ISBN 1-58017-577-5, \$14.95, 96 pages, hardbound.

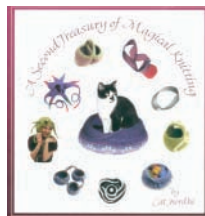

A Second Treasury of Magical Knitting

Cat Bordhi (Passing Paws Press)

Knitters who like to travel beyond the ordinary were captivated by the magic in Bordhi's first *Treasury of Magical Knitting*. Now her *Second Treasury* provides enchanting designs for knitted and felted bowls, baskets, bags, and cat beds.

Complete instructions are given for the knitter new to Bordhi's unusual approach to knitting; her advanced techniques open doors to endlessly innovative forms of knitting. ISBN 0-9708869-8-5, \$26.95, 112 pages, softbound.



Ponchos & Wraps—A Knitter's Dozen (XRX Books)

Glamorous or casual, cozy-warm or light and airy, ponchos make a definite fashion statement. XRX brings us twenty-two fabulous wraps in gorgeous yarns and captivating styles. Garter-stitch or cables, lace or mitered-squares, there is something

for everyone in this beautifully photographed book. To further tempt and inspire you, several of the designs are shown with variations, so you can make a statement that is uniquely your own. ISBN 193306401-3, \$15.95, 88 pages, softbound.



Not just Socks

Sandi Rosner (Unicorn)

Self-striping yarns are hotter than ever, and Sandi Rosner knows just how to make the best of their versatility. She gives us a variety of sock patterns with lots of ways to do heels, then goes on to offer fingerless gloves, legwarmers, hats, scarves, and even

a stylish poncho. The projects range from easy to intermediate, and all take full advantage of the magical properties of self-patterning yarn. ISBN 1-893063-10-0, \$18.95, 76 pages, softbound.



The Ultimate Knitted Tee

Laura Miltzer Bryant and Barry Klein (Martingale)

This new book celebrates the variety of knitted tees. With a wealth of design experience between them, Bryant and Klein give us the definitive manual on knitting this wardrobe essential in the prettiest novelty yarns. The designs are organized according to construction method and provide knitters with a treasure trove of styles. With easy

tops suitable for beginners, and tees that allow experienced knitters to show off their skills, the biggest problem you'll have will be deciding which tee to make first. ISBN 1-56477-557-7, \$29.95, 143 pages, softbound.

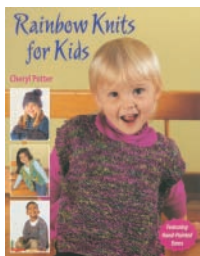

Rainbow Knits for Kids

Cheryl Potter (Martingale)

Cheryl Potter, owner of Cherry Tree Hill Yarns, uses beautiful handpainted yarns in a collection of children's knitwear that is practical, comfortable, and above all, colorful. The two dozen quick-to-knit projects are worked in fibers that are child-friendly (not to mention washable!). Sized for children three through eight, the designs include ponchos, sweaters, hats, mittens, and more.

ISBN 1-56477-564-X, \$27.95, 112 pages, softbound.

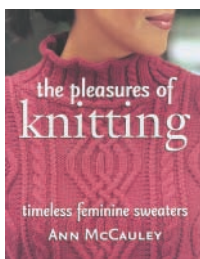

The Pleasures of Knitting: Timeless Feminine Sweaters

Ann McCauley (Martingale)

Characterized by classic beauty, McCauley's patterns have a sense of grace and movement in their simple lines and intricate stitch patterns, and her body-conscious silhouettes are lovely and flattering. The thirteen sweaters in this book beg to be knitted in rich colors and favorite yarns. The section on knitting tips, which includes wrist stretches

and posture suggestions, is a nice bonus. ISBN 1-56477-566-6, \$27.95, 96 pages, softbound.

Visit our website at www.interweaveknits.com for more reviews.

BERROCO®

Way to knit!

Log on to www.berroco.com and check out our 4 newest pattern books and yarns for Spring 2005.



 **BERROCO**
www.berroco.com
First in fashion

ONE-BUTTON CARDIGAN

design by MARI LYNN PATRICK

A SINGLE BUTTON SECURES THIS CUTAWAY CARDIGAN made in the softest cashmere. The body, worked in a zigzag eyelet pattern, is shaped like an elongated bolero. When the shoulder and side seams have been completed, the wide, eyelet-ribbed border is picked up and worked along the lower front and back edges. The deep, curved foldover collar is shaped with short rows and the picot bind-off edge is worked in a combination of knit and crochet.

Finished Size 36 (40½, 44, 49)" (91.5 [103, 112, 124.5] cm) bust/chest circumference, buttoned. Sweater shown measures 40½" (103 cm).

Yarn Plymouth Royal Cashmere (100% cashmere; 154 yd [141 m]/50 g): #814N pistachio, 8 (9, 10, 11) skeins.

Needles Body and sleeves—Size 7 (4.5 mm): straight. Edging—Size 5 (3.75 mm): 40" (100-cm) circular (cir). Adjust needle size if necessary to obtain the correct gauge.

Notions Markers (m); size E/4 (3.5 mm) crochet hook; tapestry needle; one 1¼" (3.2-cm) button.

Gauge 19 sts and 26 rows = 4" (10 cm) in zigzag patt from chart on larger needles.

Stitch Guide

Rib Pattern for Collar: (mult of 4 sts, inc to mult of 5 sts + 4)

Row 1: (RS of collar; WS of garment) K1, *k2, p2; rep from * to last 3 sts, k3.

Row 2: (WS of collar; RS of garment) P3, *k1, yo, k1, p2; rep from * to last st, p1—mult of 5 sts + 4.

Row 3: K1, *k2, p3; rep from * to last 3 sts, k3.

Row 4: P3, *k1, ssk (see Glossary, page 105), p2; rep from * to last st, p1—mult of 4 sts.

Repeat Rows 1–4 for pattern.

Notes

The deep ribbed edging for the lower fronts and back is worked in one piece after the main garment pieces are knitted and assembled. The short-rowed collar is worked in one piece along the shaped edges of the front V-neck, top of each raglan sleeve, and back neck. The lower edging and collar are not shown on the schematic.

When working short-rows for collar, maintain stitches in pattern as much as possible. For example, if there are not enough stitches to work the p3 columns in Row 3 of the rib pattern for collar, work those stitches as p2 instead, and when working Row 4 of the collar pattern, work these stitches as k2 instead of k1, ssk. If there are too many sts to work the k2, p2 in Row 1 of the collar pattern, work decreases as necessary to restore the k2, p2 pattern.

Back

With larger straight needles, CO 72 (82, 90, 102) sts. **Next row:** (WS) K1 (selvage st; knit every row), purl to last st, k1 (selvage

st; knit every row). **Next row:** (RS) Establish patt as foll: K1 (selvage st), k2 (1, 0, 0), work 11-st rep of Row 1 of Zigzag chart (see page 16) 6 (7, 8, 9) times, k2 (2, 0, 1), k1 (selvage st). Work 5 rows even in patt. **Shape sides:** (RS) Cont in patt, inc 1 st each end of needle inside selvage sts—74 (84, 92, 104) sts. Working inc'd sts in St st, work 7 rows even in patt. Cont in patt, rep the shaping of the last 8 rows 5 more times, then work inc row once more—86 (96, 104, 116) sts; piece should measure about 8¾" (22 cm) from CO. Work even in patt until piece measures 9½" (10, 10½, 11)" (24 [25.5, 26.5, 28] cm) from CO, ending with a WS row. **Shape raglan:** **Dec row:** (RS) K1, ssk, work in patt to last 3 sts, k2tog, k1—2 sts dec'd. Work 1 WS row even. Rep the shaping of the last 2 rows 1 (5, 10, 19) more time(s)—82 (84, 82, 76) sts rem. Work dec row every 4th row 12 (11, 9, 5) times—58 (62, 64, 66) sts rem. Work even if necessary until raglan measures 8 (8½, 9, 9¼)" (20.5 [21.5, 23, 23.5] cm), ending with a WS row. BO all sts.

Left Front

With larger straight needles, CO 7 sts. Purl 1 WS row. **Note:** Side and center front shaping are worked at the same time; read the next section all the way through before proceeding. **Shape lower edge and side:** **Next row:** (RS) K1 (selvage; knit every row), work 6 sts according to first 6 sts of Row 1 of Zigzag chart. **Next row:** (WS) Using the cable method (see Glossary, page 104), CO 2 sts (front edge), purl to end—9 sts. Cont in patt, CO 2 sts at beg of every WS row (front edge) 12 (15, 16, 19) more times, working new sts in zigzag patt as they become established. Work a maximum of 22 (33, 33, 44) sts in zigzag patt, then work rem sts in St st, and re-establish 1 selvage st at front edge when all cast-ons have been completed. **At the same time,** beg with Row 7 of patt (RS), inc 1 st at beg of needle (side edge) inside selvage st every 10 rows 5 times total, working new side sts in St st—38 (44, 46, 52) sts; 1 selvage st and 5 St sts at side edge; 22 (33, 33, 44) sts in zigzag patt; 9 (4, 6, 1) St st(s) and 1 selvage st at front edge; piece should measure about 8¾" (22 cm) from CO when all shaping has been completed. Work even in patt until piece measures 9½" (10, 10½, 11)" (24 [25.5, 26.5, 28] cm) from CO, ending with a WS row. Mark the front edge of the last row completed with waste yarn to indicate beg of neck shaping. **Note:** Raglan and neck shaping are worked at the same time; read the next section all the way through before proceeding. **Shape raglan and neck:** **Dec row:** (RS) K1, ssk (armhole dec), work in patt to



last 3 sts, k2tog (neck dec), k1—2 sts dec'd. Dec 1 st at end of RS rows (neck edge) in this manner 23 (26, 25, 26) more times, and *at the same time*, at armhole edge (beg of RS rows) dec 1 st every RS row 1 (5, 10, 19) more time(s), then every *other* RS row 12 (11, 9, 5) times—raglan should measure about 8 (8½, 9, 9¼)" (20.5 [21.5, 23, 23.5] cm).

Right Front

With larger straight needles, CO 7 sts. Purl 1 WS row. *Note:* Side and center front shaping are worked at the same time; read the next section all the way through before proceeding. **Shape lower edge and side:** *Next row:* (RS) Using the cable method, CO 2 sts, work 6 sts according to last 6 sts of Row 1 of Zigzag chart, k1 (selvedge st; knit every row). *Next row:* (WS) K1, purl to end. Cont in patt, CO 2 sts at beg of every RS row (front edge) 12 (15, 16, 19) more times, working new sts in zigzag patt as they become established. Work a maximum of 22 (33, 33, 44) sts in zigzag patt, then work rem new sts in St st, and re-establish 1 selvedge st at front edge when all cast-ons have been completed. *At the same time*, beg with Row 7 of patt (RS), inc 1 st at end of needle (side edge) inside selvedge st every 10 rows 5 times total, working new side sts in St st—38 (44, 46, 52) sts; 1 selvedge st and 9 (4, 6, 1) St st(s) at front edge; 22 (33, 33, 44) sts zigzag patt; 5 St sts and 1 selvedge st at side edge; piece should measure about 8¾" (22 cm) from CO when all shaping has been completed. Work even in patt until piece measures 9½ (10, 10½, 11)" (24 [25.5, 26.5, 28] cm) from CO, ending with a WS row. Mark the front edge of the last row completed with waste yarn to indicate beg of neck shaping. *Note:* Raglan and neck shaping are worked at the same time; read the next section all the way through before proceeding. **Shape raglan and neck:** *Dec row:* (RS) K1, ssk (neck dec), work in patt to last 3 sts, k2tog (armhole dec), k1—2 sts dec'd. Dec 1 st at beg of RS rows in this manner 23 (26, 25, 26) more times, and *at the same time*, dec 1 st at end of every RS row 1 (5, 10, 19) more time(s), then every *other* RS row 12 (11, 9, 5) times.

Sleeves

With larger straight needles, CO 43 (43, 45, 47) sts. *Next row:* (WS) K1 (selvedge st; knit every row), purl to last st, k1 (selvedge st; knit every row). *Next row:* (RS) Establish patt as foll: (RS) K1 (selvedge st), k4 (4, 5, 6), work 11-st rep from Row 1 of Zigzag chart 3 times, k4 (4, 5, 6), k1 (selvedge st). Work 5 rows even in patt. *Next row:* (RS) Inc 1 st each end of needle inside selvedge sts, working inc'd sts in St st—45 (45, 47, 49) sts. Work 5 rows even in patt. Cont in patt, rep the shaping of the last 6 rows 6

(7, 8, 9) more times, then work inc row once more—59 (61, 65, 69) sts. Work even in patt if necessary until piece measures 9 (9½, 10, 10½)" (23 [24, 25.5, 26.5] cm) from CO, ending with a WS row. **Shape raglan:** *Dec row:* (RS) K1, ssk, work in patt to last 3 sts, k2tog, k1—2 sts dec'd. Work 1 WS row even. Rep the shaping of the last 2 rows 13 (13, 16, 19) more times—31 (33, 31, 33) sts rem. Work dec row every 4th row 6 (7, 6, 5) times—19 sts rem. Work even if necessary until raglan measures 8 (8½, 9, 9¼)" (20.5 [21.5, 23, 23.5] cm), ending with a WS row. BO all sts. **Sleeve cuff:** With smaller needles and RS facing, pick up and knit 42 (42, 46, 46) sts along CO edge of sleeve. Work rib as foll:

Row 1: (WS) K2, *p2, k2; rep from *.

Row 2: (RS) P2, *k2, p2; rep from *.

Row 3: K1, yo, k1, *p2, k1, yo, k1; rep from *—53 (53, 58, 58) sts.

Row 4: P3, *k2, p3; rep from *.

Row 5: K1, ssk, *p2, k1, ssk; rep from *—42 (42, 46, 46) sts rem.

Rep Rows 2–5 (do not rep Row 1) 6 more times, ending with Row 5—29 cuff rows completed; cuff should measure about 4" (10 cm) from pick-up row. **Looped bind-off:** With RS facing, *BO 3 sts in rib, transfer rem st on right needle to crochet hook, ch 6 (see Glossary, page 106, for crochet instructions), place st back on right needle, sl next st from left needle to right needle, pass the st from the ch-6 over the 2nd st; rep from * until 3 sts or fewer rem on left needle. BO rem sts.



Finishing

Block pieces to measurements. With yarn threaded on a tapestry needle, sew side seams, sew sleeves to body along raglan seams, and sew sleeve seams. **Lower fronts and back edging:** With cir needle, RS facing, and beg at waste yarn marker at beg of left front neck shaping, pick up and knit 27 (29, 31, 33) sts along straight selvedge of left front, 50 (56, 62, 68) sts along shaped lower edge of left front, place marker (pm), 5 sts across CO edge of left front, 5 sts from CO edge of back, pm, 66 (74, 78, 90) sts across CO edge of back to last 5 back sts, pm, rem 5 sts of back, 5 sts across CO edge of right front, pm, 50 (56, 62, 68) sts along shaped lower edge of right front, and 27 (29, 31, 33) sts along straight selvedge of right front to waste yarn marker at beg of right front neck shaping—240 (264, 284, 312) sts total; 10 sts between the pairs of markers centered over each side seam.

Row 1: (WS) K1, p2, *k2, p2, rep from * to last st, k1. The 10-st section between each pair of markers should have been worked as [p2, k2] 2 times, p2 on the row just completed.

Row 2: (RS) P1, k2, *p2, k2; rep from * to last st, p1.

Row 3: K1, p2, *k1, yo, k1, p2; rep from * to last st, k1—299 (329, 354, 389) sts; 12 sts in each marked section.

Rebecca



Now
available
in English!

“Three’s
Company”



www.rebecca-online.com/ photo: nicole neumann

For a Retailer near you email us at: rebecca@muenchyarns.com
The new Rebecca, Knitwear designs easier than ever!

Row 4: P1, k2, *rep [p3, k2] to 3 sts before first marked section, p3, slip marker (sl m), M1 kwise (see Glossary, page 105), [k2, p3] 2 times, k2, M1 kwise, sl m; rep from * once more, rep [p3, k2] to last st, p1—303 (333, 358, 393) sts; 14 sts in each marked section.

Row 5: K1, p2, *rep [k1, ssk, p2] to 3 sts before marked section, k1, ssk, sl m, p3, [k1, ssk, p2] 2 times, p1, sl m; rep from * once more, rep [k1, ssk, p2] to last st, k1—244 (268, 288, 316) sts; 12 sts in each marked section.

Row 6: P1, k2, *rep [p2, k2] to 2 sts before marked section, p2, sl m, k1, M1 kwise, [k2, p2] 2 times, k2, M1 kwise, k1, sl m; rep from * once more, rep [p2, k2] to last st, p1—248 (272, 292, 320) sts; 14 sts in each marked section.

Row 7: K1, p2, *rep [k1, yo, k1, p2] to 2 sts before marked section, k1, yo, k1, sl m, p4, [k1, yo, k1, p2] 2 times, p2, sl m; rep from * once more, rep [k1, yo, k1, p2] to last st, k1—307 (337, 362, 397) sts; 16 sts in each marked section.

Row 8: P1, k2, *rep [p3, k2] to 3 sts before first marked section, p3, sl m, k2, M1 pwise (see Glossary, page 105), [k2, p3] 2 times, k2, M1 pwise, k2, sl m; rep from * once more, rep [p3, k2] to last st, p1—311 (341, 366, 401) sts; 18 sts in each marked section.

Row 9: K1, p2, *rep [k1, ssk, p2] to 3 sts before marked section, k1, ssk, sl m, p2, k1, [p2, k1, ssk] 2 times, p2, k1, p2, sl m; rep from * once more, rep [k1, ssk, p2] to last st, k1—252 (276, 296, 324) sts; 16 sts in each marked section.

Row 10: P1, k2, *rep [p2, k2] to 2 sts before marked section, p2, sl m, k2, p1, M1 pwise, [k2, p2] 2 times, k2, M1 pwise, p1, k2, sl m; rep from * once more, rep [p2, k2] to last st, p1—256 (280, 300, 328) sts; 18 sts in each marked section.

Row 11: K1, p2, *rep [k1, yo, k1, p2] to 2 sts before marked section, k1, yo, k1, sl m, [p2, k1, yo, k1] 4 times, k2, sl m; rep from * once more, rep [k1, yo, k1, p2] to last st, k1—319 (349, 374, 409) sts; 22 sts in each marked section.

Row 12: P1, k2, *rep [p3, k2] to 3 sts before first marked section, p3, sl m, k2, p3, M1 kwise, [k2, p3] 2 times, k2, M1 kwise, p3, k2, sl m; rep from * once more, rep [p3, k2] to last st, p1—323 (353, 378, 413) sts; 24 sts in each marked section.

Row 13: K1, p2, *rep [k1, ssk, p2] to 3 sts before marked section, k1, ssk, sl m, p2, k1, ssk, p1, [p2, k1, ssk] 2 times, p3, k1, ssk, p2, sl m; rep from * once more, rep [k1, ssk, p2] to last st, k1—260 (284, 304, 332) sts; 20 sts in each marked section.

Row 14: (buttonhole row) P1, k2, *rep [p2, k2] to 2 sts before marked section, p2, sl m, k2, p2, k1, M1 kwise, [k2, p2] 2 times,

k2, M1 kwise, k1, p2, k2, sl m; rep from * once more, rep [p2, k2] to last 9 sts, p2, BO 4 sts for buttonhole, k2, p1—264 (288, 308, 336) sts; 22 sts in each marked section.

Row 15: Work as foll, using the cable method to CO 4 sts over the gap in previous row to complete buttonhole: K1, p2, *rep [k1, yo, k1, p2] to 2 sts before marked section, k1, yo, k1, sl m, p2, k1, yo, k1, p4, [k1, yo, k1, p2] 2 times, p2, k1, yo, k1, p2, sl m; rep from * once more, rep [k1, yo, k1, p2] to last st, k1—327 (357, 382, 417) sts; 26 sts in each marked section.

Row 16: P1, k2, *rep [p3, k2] to 3 sts before first marked section, p3, sl m, k2, p3, k2, M1 pwise, [k2, p3] 2 times, k2, M1 pwise, k2, p3, k2, sl m; rep from * once more, rep [p3, k2] to last st, p1—331 (361, 386, 421) sts; 28 sts in each marked section.

Row 17: K1, p2, *rep [k1, ssk, p2] to 3 sts before marked section, k1, ssk, sl m, p2, k1, ssk, p2, k1, [p2, k1, ssk] 2 times, p2, k1, p2, k1, ssk, p2, sl m; rep from * once more, rep [k1, ssk, p2] to last st, k1—268 (292, 312, 340) sts; 24 sts in each marked section.

Row 18: P1, k2, *rep [p2, k2] to 2 sts before marked section, p2, sl m, k2, p2, k2, p1, M1 pwise, [k2, p2] 2 times, k2, M1 pwise, p1, k2, p2, k2, sl m; rep from * once more, rep [p2, k2] to last st, p1—272 (296, 316, 344) sts; 26 sts in each marked section.

Row 19: K1, p2, *k1, yo, k1, p2; rep from * to last st, k1—339 (369, 394, 429) sts.

Row 20: P1, k2, *p3, k2; rep from * to last st, p1.

Row 21: K1, p2, *k1, ssk, p2; rep from * to last st, k1—272 (296, 316, 344) sts.

Row 22: P1, k2, *p2, k2; rep from * to last st, p1.

Rows 23–29: Rep Rows 19–22 once, then work Rows 19–21 once more—272 (296, 316, 344) sts.

Work looped BO as for sleeve cuff. **Collar:** Note: The WS of collar corresponds to the RS of garment so RS of collar will show when collar is folded back. With cir needle, RS facing, and beg at waste yarn marker at beg of right front neck shaping, pick up and knit 42 (44, 46, 48) sts along right front V-neck, 18 sts across top of right sleeve, pm, 56 (60, 64, 68) sts across back neck, pm, 18 sts across top of left sleeve, 42 (44, 46, 48) sts along left front V-neck to scrap yarn marker at beg of left front neck shaping—176 (184, 192, 200) sts total. *Next row:* (RS of collar; WS of garment) Work Row 1 of rib patt for collar (see Stitch Guide). Maintaining patt (see Notes), work short-rows to create shawl collar as foll:

Short-row 1: (WS of collar; RS of garment) Work Row 2 of rib patt to second shoulder marker (left shoulder), wrap next st (see Glossary, page 105), turn.

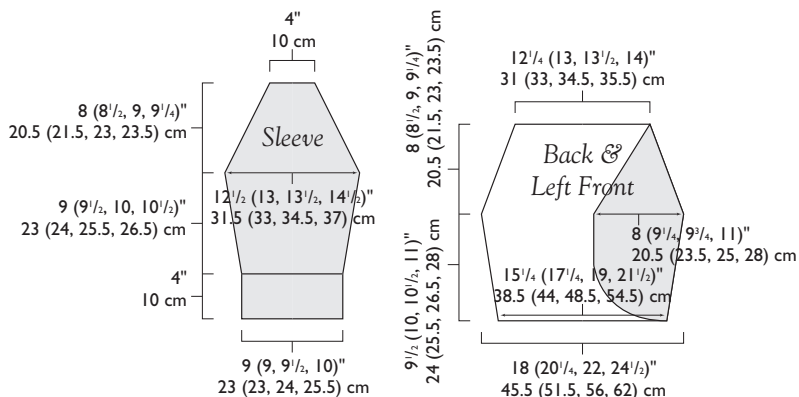
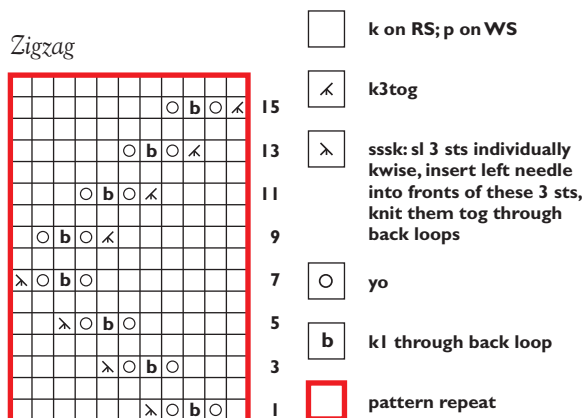



Short-row 2: (RS of collar; WS of garment) Work Row 3 of rib patt to other shoulder marker (right shoulder), wrap next st, turn.

Short-row 3: Work next row of rib patt to 3 sts beyond previous wrapped st on left side, wrap next st, turn.

Short-row 4: Work next row of rib patt to 3 sts beyond previous wrapped st on right side, wrap next st, turn.

Rep the last 2 rows 14 (14, 15, 15) more times, always working 3 sts beyond the wrapped st of the previous row before wrapping the next st; in other words, every 4th st will have a wrap—33 (33, 35, 35) patt rows completed at back neck; 0 (2, 0, 2) sts rem unworked at each end of row after last short-row. Work 28 rows even in patt across all sts, working each wrapped st tog with its wrap as you come to it on the first row, ending with Row 1 (1, 3, 3) of patt. *Next row:* For all sizes, work Row 4 of patt once more; do not work inc Row 2 of patt for the two smaller sizes—62 (62, 64, 64) patt rows completed at center back neck; collar measures about 4" (10 cm) from pick-up row each end, and 8¼ (8¼, 8½, 8½)" (21 [21, 21.5, 21.5] cm) from pick-up row at center back. Work looped BO as for sleeve cuff. With yarn threaded on a tapes-try needle, sew selvages of collar and lower edging tog at each front with seam allowance on WS of garment. Sew button oppo-site buttonhole. Weave in loose ends. ∞

Mari Lynn Patrick lives in Baltimore, Maryland, where she writes and knits for the knitwear industry.



Celebrate Spring & Summer
with a Great New Yarn from
Dale of Norway

Flamingo

66% Cotton/34% Nylon, Machine Washable

5 Great Color Combinations for
Your Spring & Summer Knitting
8 Exciting Patterns in Family Book 156

Call 800-441-DALE
for the Store Nearest You & Our Free Brochure,
or Go Online at www.dale.no

In Canada, call Estelle Designs at 800-387-5167



DALE OF NORWAY®

N16W23390 Stoneridge Dr., Ste. A, Waukesha, WI 53188

ISIS WRAP

design by KATHLEEN POWER JOHNSON

A KIMONO SLEEVE CREATES A SMOOTH SHOULDER LINE in this brief summer sweater, whose lace pattern reminds Kathleen Power Johnson of rippling water. The fronts and back are worked separately from the lower edges to the armhole, then stitches are cast on and worked for the sleeves. Ribbed front ties allow for an adjustable fit; work longer ties for a wraparound version of the sweater.

Finished Size 35½ (40, 47½)" (90 [101.5, 120.5] cm) bust circumference, tied. Sweater shown measures 40" (101 cm).

Yarn Tahki New Tweed (70% merino, 15% silk, 11% cotton, 4% viscose; 103 yd [95 m]/50 g): #018 blue, 5 (6, 8) balls.

Needles Size 9 (5.5 mm). Adjust needle size if necessary to obtain the correct gauge.

Notions Removable markers or safety pins; stitch holders; tapestry needle.

Gauge 17 sts and 24 rows = 4" (10 cm) in lace patt.

Stitch Guide

Selvedge stitches: Unless otherwise specified, slip the first st of every row (kwise for knit sts, pwise for purl sts); knit the last st of every row.

Lace Pattern: (multiple of 8 sts + 3)

Row 1: (RS) K1, *k2, yo, ssk, k1, k2tog, yo, k1; rep from * to last 2 sts, k2.

Rows 2, 4, and 6: (WS) Purl.

Row 3: K1, *k1, yo, ssk, yo, sl 2 tog kwise, k1, p2sso, yo, k2tog, yo; rep from * to last 2 sts, k2.

Rows 5 and 7: K1, *k1, yo, sl 2 tog kwise, k1, p2sso, yo; rep from * to last 2 sts, k2.

Row 8: Purl.

Repeat Rows 1–8 for pattern.

Note

If there are not enough stitches as a result of shaping to work a yarnover or decrease with its companion decrease or yarnover, work the stitches in stockinette stitch until there are enough stitches to resume working in pattern.

Back

CO 69 (77, 93) sts. Work in k1, p1 rib until piece measures 1" (2.5 cm), ending with a WS row. Establish selvedge sts and lace patt on next row as foll: (RS) Sl 1 (selvedge st; see Note), work Row 1 of lace patt

over center 67 (75, 91) sts, k1 (selvedge st). Work 1 WS row even. **Shape sides:** (RS) Inc 1 st each end of needle inside selvedge sts—71 (79, 95) sts. Work 3 rows even. Cont in patt, rep the shaping of the last 4 rows 1 (2, 2) more time(s), then work inc row once more—75 (85, 101) sts; 11 (15, 15) patt rows completed, ending with Row 3 (7, 7) of patt. Work 1 WS row even—piece should measure about 3 (3¾, 3¾)" (7.5 [9.5, 9.5] cm) from beg. **Shape sleeves:** Using the knitted method (see Glossary, page 105), CO 2 sts at beg of next 8 (10, 14) rows, then CO 3 sts at beg of foll 2 (4, 6) rows, then CO 5 sts at beg of foll 4 rows, then CO 6 sts at beg of foll 2 (2, 4) rows, then CO 7 sts at beg of foll 8 (6, 2) rows, working CO sts into patt—185 (191, 205) sts; piece should measure about 7 (8¼, 8¼)" (18 [21, 22] cm) from beg. Mark each end of last row completed with safety pin or scrap yarn to indicate end of sleeve shaping. Work even in

patt for 2½" (6.5 cm) beyond sleeve markers, ending with a WS row—piece should measure about 9½ (10¾, 11¼)" (24 [27.5, 28.5] cm) from beg. **Shape back neck:** Cont in patt, work 82 (85, 92) sts, join new yarn and BO 21 sts for neck, work to end of row—82 (85, 92) sts at each side. Working each side separately, at each neck edge BO 5 sts once—77 (80, 87) sts rem each side. Cont even in patt until piece measures 11½ (12¾, 13¼)" (29 [32.5, 33.5] cm) from beg, or about 4½" (11.5 cm) from sleeve markers for all sizes, ending with a RS row. BO all sts.

Right Front

CO 106 (114, 122) sts. Work k1, p1 rib until piece measures 1" (2.5 cm), ending with a WS row. **Next row:** (RS) BO 74 sts for tie (1 st rem on right needle), work next 3 sts in established rib, pm, work Row 1 of lace patt over next 27 (35, 43) sts, k1 (selvedge st)—32 (40, 48) sts. **Next row:** (WS) Sl 1 (selvedge st), work in patt to last 4 sts, work 4 sts in rib. **Note:** The side, neck, and sleeve shap-





ing are worked at the same time; read the next section all the way through before proceeding. Keep 1 st at side edge (end of RS rows; beg of WS rows) as a selvedge st and maintain 4 sts at center front edge (beg of RS rows; end of WS rows) in k1, p1 rib; do not slip the first st of the ribbed edging on RS rows. **Shape side, front neck, and sleeves:** Beg with the next RS row (Row 3 of patt), inc 1 st at side edge inside selvedge st every 4th row 3 (4, 4) times total, and *at the same time* dec 1 st at neck edge inside rib sts every 4th row 3 (4, 4) times, ending with Row 3 (7, 7) of patt—still 32 (40, 48) sts; 11 (15, 15) patt rows completed; side shaping is finished for all sizes. Cont to dec 1 st at neck edge inside rib sts every 4th row 6 (9, 9) more times, and *at the same time*, beg with the next WS row, shape sleeve as foll: use the cable method (see Glossary, page 104) to CO 2 sts at beg of next 4 (5, 7) WS rows, then CO 3 sts at beg of foll 1 (2, 3) WS row(s), then CO 5 sts at beg of foll 2 WS rows, then CO 6 sts at beg of foll 1 (1, 2) WS row(s), then CO 7 sts at beg of foll 4 (3, 1) WS row(s), working CO sts in patt. Mark cuff edge of last sleeve CO row to indicate end of sleeve shaping, about 7 (8¼, 8¾)" (18 [21, 22] cm) from beg. When all neck and sleeve shaping has been completed, there will be 81 (84, 91) sts—55 (53, 52) sts CO for sleeve; 6 (9, 9) more sts dec'd at neck edge. Work even until piece measures 11½ (12¾, 13¼)" (29 [32.5, 33.5] cm) from beg, or about 4½" (11.5 cm) from sleeve marker, ending with a RS row. **Next row:** (WS) BO 77 (80, 87) sts, place rem 4 sts of rib band on holder.

Left Front

CO 106 (114, 122) sts. Work in k1, p1 rib until piece measures 1" (2.5 cm), ending with a RS row. **Next row:** (WS) BO 74 sts for tie, work in rib patt to end—32 (40, 48) sts. **Next row:** (RS) Sl 1 (selvedge st), pm, work Row 1 of lace patt over next 27 (35, 43) sts, pm, work 4 sts in rib. Work 1 WS row even. **Note:** The side, neck, and sleeve shaping are worked at the same time; please read the next section all the way through before proceeding. Keep 1 st at side edge (beg of RS rows, end of WS rows) as a selvedge st and maintain 4 sts at center front edge (end of RS rows, beg of WS rows) in k1, p1 rib; do not slip the first st of the ribbed edging on WS rows. **Shape side, front neck, and sleeves:** Beg with the next RS row (Row 3 of patt), inc 1 st at side edge inside selvedge st every 4th row 3 (4, 4) times total, and *at the same time* dec 1 st at neck edge

inside rib sts every 4th row 3 (4, 4) times, ending with Row 3 (7, 7) of patt—still 32 (40, 48) sts; 11 (15, 15) patt rows completed; side shaping is finished for all sizes. Work 1 WS row even. Cont to dec 1 st at neck edge inside rib sts every 4th row 6 (9, 9) more times, and *at the same time*, beg with the next RS row, use the knitted method to shape sleeve as foll: CO 2 sts at beg of next 4 (5, 7) RS rows, then CO 3 sts at beg of foll 1 (2, 3) RS row(s), then CO 5 sts at beg of foll 2 RS rows, then CO 6 sts at beg of foll 1 (1, 2) RS row(s), then CO 7 sts at beg of foll 4 (3, 1) RS row(s), working CO sts in patt. Mark cuff edge of last sleeve CO row to indicate end of sleeve shaping, about 7 (8¼, 8¾)" (18 [21, 22] cm) from beg. When all neck and sleeve shaping has been completed there will be 81 (84, 91) sts. Work even until piece measures 11½ (12¾, 13¼)" (29 [32.5, 33.5] cm) from beg, or about 4½" (11.5 cm) from sleeve marker, ending with a WS row. **Next row:** (RS) BO 77 (80, 87) sts, place rem 4 sts of rib band on holder.

Finishing

With yarn threaded on a tapestry needle, sew shoulder and side seams. **Right neckband:** Return 4 held sts from right front to needle and join yarn with RS facing.

Row 1: (RS) Work 4 sts in rib, pick up and knit 1 st from neck edge—5 sts.

Rows 2 and 4: Work even in rib, working picked-up st in patt.

Row 3: Work established rib to end, pick up and knit 1 st from neck edge—6 sts.

Row 5: Work 4 sts in rib, ssk, pick up and knit 1 st from neck edge—still 6 sts.

Row 6: Work in established rib. Cont to rep Rows 5 and 6 until band reaches center back when slightly stretched. Cut yarn, leaving a 14" (35.5-cm) tail. Place sts on holder.

Left neckband: Return 4 held sts from left front to needle and join yarn with WS facing.

Row 1: (WS) Work 4 sts in rib, pick up and purl 1 st from neck edge—5 sts.

Rows 2 and 4: Work even in rib, working picked-up st in patt.

Row 3: Work established rib to end, pick up and purl 1 st from neck edge—6 sts.

Row 5: Work 4 sts in rib, p2tog, pick up and purl 1 st from neck edge—still 6 sts.

Row 6: Work in established rib.

Rep Rows 5 and 6 until band reaches center back when slightly stretched. Cut yarn and place sts on holder. With tail threaded on a tapestry needle, use the Kitchener st for ribbing (see Glossary, page 105) to join bands tog at center back, adding or removing rows to adjust length of bands if necessary. Weave in loose ends. ☞

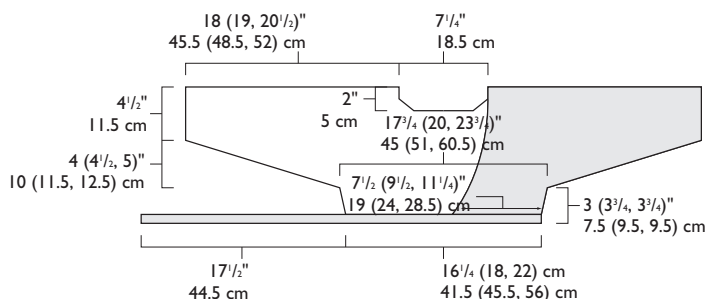

KATHLEEN POWER JOHNSON lives in Sarasota, Florida.



Brown Sheep Company, Inc.

1-800-826-9136

**Quality Yarn
from
Quality People**



**DYED
FOR
EWE!**

**MADE
IN THE
U.S.A.**

www.brownsheep.com

SUMMER SUNDRESS

design by MARI LYNN PATRICK

INSPIRED BY A LACE PATTERN FROM A BEDSPREAD made in the late nineteenth century, and by modern slip dresses from the New York runways, Mari Lynn Patrick has created this lovely knitted dress. Lace panels worked horizontally form the hem edging and waistband and accentuated decreases form delicate points on the tapered skirt. For stability and to resist stretching, the bodice is knitted side-to-side. Tiny shell buttons and slender I-cord straps add to the vintage charm.

Finished Size 34¼ (38¾)" (87 [97] cm) bust circumference; horizontal lace panel at lower edge of bodice measures 31 (35¼)" (78.5 [89.5] cm) circumference. Dress shown measures 34¼" (87 cm) at bust.

Yarn Muench Mystik (54% cotton, 46% viscose; 121 yd [110 m]/50 g): #55 soft blue-green, 11 (14) balls.

Needles Size 5 (3.75 mm): 24" (60-cm) circular (cir) and 2 double-pointed (dnp). Adjust needle size if necessary to obtain the correct gauge.

Notions Markers (m); removable markers or safety pins; tapestry needle; four ⅜" (1-cm) buttons; spare 24" (60-cm) cir same size or smaller than main needle for three-needle bind-off; size E/4 (3.5 mm) crochet hook; sharp-pointed sewing needle and matching thread.

Gauge 23 sts and 28 rows = 4" (10 cm) in St st; 30 sts (at widest point) and 24 rows of lace hem patt from chart measures about 4½" (11.5 cm) wide and 3" (7.5 cm) high; 15 to 17 sts and 28 rows of double rose leaf patt from chart measures about 2¼" (5.5 cm) wide and 4" (10 cm) high; 6 sts of lace insertion patt measure about 1" (2.5 cm) wide.

Stitch Guide

Lace Insertion: (worked over 6 sts)

Set-up row: (WS) K1, p2, yo, p2tog, p1.

Row 1: (RS) P1, k2, yo, ssk, p1.

Row 2: K1, p2, yo, p2tog, k1.

Repeat Rows 1 and 2 for pattern; do not repeat set-up row.

Bobble: ([K1, yo] 2 times, k1) all in same st, turn, p5, turn, k5, turn, p2tog, p1, p2tog, turn, sl 1, k2tog, pss0—1 st. On foll WS row, knit the bobble st through the back loop (k1tbl).

Note: On the skirt back and bodice back, do not work the bobble on Row 5. Instead, work the bobble symbol on the chart as p1 on the RS row where it appears, and work the same st on the foll WS row as k1 (not through the back loop).

Bodice Trim: (worked over 8 sts)

Set-up row: (WS) K1, p2, yo, p2tog, k1, p2.

Row 1: (RS) K2, p1, k2, yo, ssk, p1.

Row 2: K1, p2, yo, p2tog, k1, p2.

Repeat Rows 1 and 2 for pattern; do not repeat set-up row.

Note

The Double Rose Leaf chart begins with 17 sts, is decreased to 15 stitches, then is increased back to 17 stitches. When stitch counts are given at key places in the pattern, this pattern is

always counted as 17 sts, even if it happens to be on a row that contains only 15 sts at that point.

Skirt Back

Lace hem: With cir needle or dnp, CO 17 sts. Knit 1 WS row. Work Rows 1–24 of Lace Hem chart (see page 26) 10 (12) times—17 sts; piece should measure about 30 (36)" (76 [91.5] cm) from beg. BO all sts. **Skirt:** With cir needle and RS facing, pick up and knit 169 (201) sts along straight selvedge of lace hem, picking up 17 sts in 9 reps, and 16 sts in 1 (3) rep(s); for the larger size, space the 3 reps with only 16 sts picked up as evenly as possible. Do not join. Establish placement of patts on next row as foll: (WS) P35 (43), place marker (pm), work 6 sts from lace insertion set-up row (see Stitch Guide), pm, p35 (43), pm, p17, pm, p35 (43), pm, work 6 sts of lace insertion set-up row, pm, p35 (43). *Next row:* (RS) Work 35 (43) sts in St st, slip marker (sl m), work 6 sts according to Row 1 of lace insertion, sl m, work 35 (43) sts in St st, sl m, work 17 sts according to Row 1 of Double Rose Leaf chart, sl m, work 35 (43) sts in St st, sl m, work 6 sts according to Row 1 of lace insertion, sl m, work 35 (43) sts in St st. Cont in established patts without working bobbles on Double Rose Leaf chart (see Notes), for 11 more rows, ending with a WS row—piece should measure about 2" (5 cm) from pick-up row. With RS facing, mark the center st of each St st panel with a removable marker or safety pin—4 marked sts. *Dec row:* (RS) *Work in patt to 1 st before marked st at center of St st panel, sl 1, k2tog, pss0 in the center of St st panel; rep from * 3 more times, work in patts to end—161 (193) sts; 33 (41) sts in each St st panel (see Note about counting sts). Work 17 rows even in patt, mark center st of each St st panel as before, then rep dec row—153 (185) sts; 31 (39) sts in each St st panel. Cont in patts as established, rep the shaping of the last 18 rows 5 (6) more times—113 (137) sts; 21 (27) sts in each St st panel. Work 17 rows even in patt, ending with a WS row. *Final dec row:* Work in patt, working ([k3, sl 1, k2tog, pss0] 3 (4) times, k3) across each St st panel—89 (105) sts; 15 (19) sts in each St st panel; piece should measure about 20 (22½)" (51 [57] cm) from pick-up row. Place sts on holder.

Skirt Front

Work as for skirt back, working bobbles on Row 5 of Double Rose Leaf chart, and working bobble st as k1tbl on Row 6—89 (105) sts on holder; 15 (19) sts in each St st panel.



Bodice Back

(Worked horizontally from right side seam to left side seam) With cir needle, CO 51 (54) sts; do not join. *Next row:* (WS) P18, pm, p25 (28), pm, work set-up row of bodice trim (see Stitch Guide) over last 8 sts. Establish patts on next row as foll: (RS) Work Row 1 of bodice trim over first 8 sts, sl m, k1, ssk, work next 22 (25) sts in St st, sl m, work Row 1 of Double Rose Leaf chart to last st, k1 (selvage st, work in St st throughout)—50 (53) sts rem; 1 st dec'd from St st section. Work 1 WS row even in patts. *Dec row:* (RS) Work bodice trim over first 8 sts, sl m, k1, ssk, work to next m in St st, sl m, work chart to last st, k1—1 st dec'd from St st section. Cont in patts, working dec row every RS row 12 more times, ending with a RS row (Row 3 of chart)—37 (40) sts rem; 8 sts in bodice trim; 11 (14) sts in St st, 17 sts in charted patt; 1 selvage st; 27 rows of chart completed; piece should measure about 4" (10 cm) from beg. Work even in patts for 22 (30) more rows, ending with Row 1 of chart—piece should measure 7¼ (8¼)" (18.5 [21] cm) from beg.

Buttonhole placket:

Row 1: (WS) P1 (selvage st), work Row 2 of chart to m, sl m, knit to end, removing m between St st section and bodice trim.

Row 2: (RS) P19 (22), work Row 3 of chart to last st, k1.

Row 3: (buttonhole row) P1, work Row 4 of chart to m, sl m, p2, *yo, p5 (6); rep from * 2 more times, yo, p2—41 (44) sts; 23 (26) sts in placket section. *Note:* The extra sts created by the buttonhole row will allow the edge of the placket to curve into gentle scallops.

Row 4: Knit to m, work Row 5 of chart to last st, k1.

Row 5: P1, work Row 6 of chart, sl m, k2, *k2tog, k4 (5); rep from * 2 more times, k2tog, k1—37 (40) sts rem; 19 (22) sts in placket section again.

On the next row, BO 19 (22) sts loosely pwise, cut yarn, and place rem 18 sts (double leaf patt and selvage st) on holder—piece should measure 8 (9)" (20.5 [23] cm) from beg.

Button placket: CO 19 (22) sts. Knit 1 (WS) row, then [knit 1 row, purl 1 row] 2 times, ending with a WS row—piece should measure about ¼" (2 cm) from CO for button placket. With RS facing, work Row 1 of bodice trim across first 8 sts, pm, work next 11 (14) sts in St st, pm, return held bodice sts to needle with RS facing, work Row 7 of Double Rose Leaf chart to last st, sl m, k1—

37 (40) sts. Cont in patt for 21 (29) more rows, ending with Row 4 of chart. *Inc row:* (RS) Work bodice trim over first 8 sts, sl m, M1 (see Glossary, page 105), work to next m in St st, sl m, work Double Rose Leaf chart to last st, k1—1 st inc'd in St st section. Cont in patt, working inc row every RS row 13 more times, working inc'd sts in St st, and ending with a WS row (Row 8 of Double Rose Leaf chart)—51 (54) sts; 8 sts in bodice trim, 25 (28) sts in St st; 17 sts in Double Rose Leaf; 1 selvage st; piece should measure about 8 (9)" (20.5 [23] cm) from button placket CO. BO all sts.



Bodice Front

(Worked horizontally from left side seam to right side seam) With cir needle, CO 9 (12) sts.

Row 1: (RS) Work Row 1 of bodice trim over first 8 sts, pm, k1 (4).

Row 2: Using the cable method (see Glossary, page 104), CO 7 sts, purl to last 8 sts, sl m, work Row 2 of bodice trim over last 8 sts—16 (19) sts.

Row 3: Work bodice trim over first 8 sts, sl m, k2, M1, knit to end—17 (20) sts.

Rep Rows 2 and 3 two more times, ending with a RS row—33 (36) sts. *Next row:* (WS) CO 18 sts, purl to last 8 sts, sl m, work bodice trim to end—51 (54) sts; piece should measure about 1¼" (3.2 cm) from CO. *Next row:* (RS) Work bodice trim over first 8 sts, sl m, k2, M1, work in St st to last 18 sts, pm, work Row 1 of Double Rose Leaf chart to last st, k1 (selvage st, work in St st throughout)—52 (55) sts. Work 1 WS row even in patts. *Inc row:* (RS) Work bodice trim over first 8 sts, sl m, k2, M1, work to next m in St st, sl m, work chart to last st, k1—1 st inc'd in St st section. Cont in patts, working inc row every RS row 11 (13) more

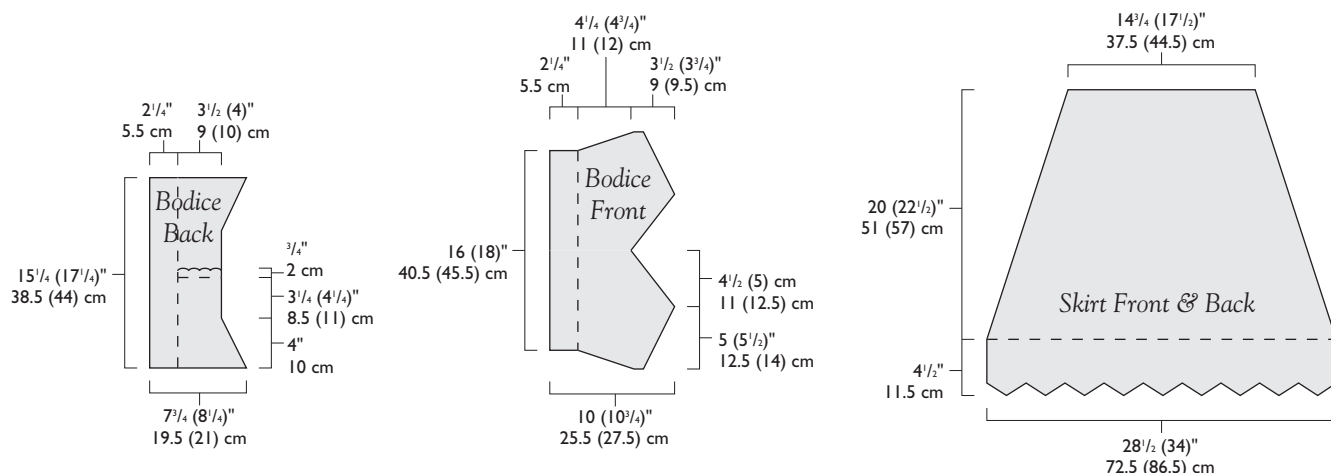



shop online
*purl*soho.com

visit our store

purl

137 SULLIVAN STREET, NEW YORK, NY 10012 (212) 420-8796

times, ending with a WS row (Row 2 [6] of chart)—64 (69) sts; 8 sts in bodice trim; 38 (43) sts in St st; 17 sts in Double Rose Leaf; 1 selvedge st; 26 (30) rows of chart completed; piece should measure about 5 (5½)" (12.5 [14] cm) from CO. *Dec row:* (RS) Work 8 sts bodice trim, sl m, k1, ssk, knit to next m, work chart to last st, end k1—1 st dec'd in St st section. Cont in patts, working dec row beg every RS row 14 (16) more times, ending with a WS row (Row 8 of chart)—49 (52) sts; 8 sts in bodice trim; 23 (26) sts in St st; 17 sts in Double Rose Leaf; 1 selvedge st; 56 (64) rows of chart completed; piece should measure about 9¼ (10¼)" (23.5 [26] cm) from CO, and 8 (9)" (20.5 [23] cm) from beg of Double Rose Leaf chart. Work center V as foll:

Row 1: (RS; center dec row; Row 1 of chart) K2, p1, sl 1, k3tog, pssso, p1 (8 sts of bodice trim dec'd to 5 sts), sl m, k1, ssk, work in patts to end—45 (48) sts; 5 sts in bodice trim; 22 (25) sts in St st, 17 sts in Double Rose Leaf; 1 selvedge st.

Row 2: (WS) Work in patt to last 5 sts, k3tog, p2—43 (46) sts; 3 sts in bodice trim; piece should measure about 9½ (10½)" (24 [26.5] cm) from CO.

Row 3: K2, M1 pwise (see Glossary, page 105), k1, M1 pwise (3 sts of bodice trim inc'd to 5 sts), sl m, k2, M1, work in patt to end—46 (49) sts; 5 sts in bodice trim; 23 (26) sts in St st, 17 sts in Double Rose Leaf; 1 selvedge st.

Row 4: Work in patt to last 5 sts, sl m, k1, M1, p1, M1, k1, p2 (5 bodice trim sts inc'd to 7 sts)—48 (51) sts.

Row 5: K2, p1, knit in front and back of next st (k1f&b), yo, ssk, p1 (7 bodice trim sts inc'd to 8 sts), sl m, k2, M1, work in patt to end—50 (53) sts; 8 sts in bodice trim; 24 (27) sts in St st, 17 sts in Double Rose Leaf; 1 selvedge st.

Resume working bodice trim on 8 sts at neck edge as before, and work 1 WS row even. *Inc row:* (RS) Work bodice trim over first 8 sts, sl m, k2, M1, work to next m in St st, sl m, work chart to last st, k1—1 st inc'd in St st section. Cont in patts, working inc row every RS row 13 (15) more times, ending with a WS row (Row 2 [6] of chart)—64 (69) sts; 8 sts in bodice trim; 38 (43) sts in St st; 17 sts in Double Rose Leaf; 1 selvedge st; 90 (102) rows of chart completed; piece should measure about 14 (15½)" (35.5 [39.5] cm) from CO. *Dec row:* (RS) Work 8 sts bodice trim, sl m, k1, ssk, knit to next m, work chart to last st, k1—1 st dec'd in St st section. Cont in patts, working dec row beg every RS row 14 (16) more times, ending with a RS row (Row 7 of chart)—49 (52) sts; 8 sts in bodice trim; 23 (26) sts in St st; 17 sts in Double Rose Leaf; 1 selvedge st. At beg of next WS row, BO 18 sts, work in patt to end—31 (34) sts; 8 sts in bodice trim; 23 (26) sts in St st. Cont in patt, dec 1 st at neck edge as before on next RS row, and at the same time BO 7 sts at beg of next 3 WS rows—9 (12) sts; piece should measure about 19 (21)" (48.5 [53.5] cm) from CO. BO rem sts on next RS row.

Finishing

Block pieces to measurements, pinning out the lace hem into points. **Join bodice and skirt:** With cir needle and RS facing, pick up and knit 89 (105) sts along lower edge of back bodice. Place 89 (105) held sts of back skirt on spare cir needle. Make sure that you are joining the back skirt (without bobbles) to the back bodice. With RS of pieces touching, use the three-needle method (see Glossary, page 106) to BO pieces tog. Join front bodice and skirt in the same way. With crochet hook, use a slip-st

seam (see Glossary, page 106) to join front and back along side seams, matching bodice trim and horizontal lace panels. **Straps:** With dpn and RS facing, leaving a 12"–15" (30- to 38-cm) tail, pick up and knit 4 sts across the top of one front bodice point, turn, p4. Work 4-st 1-cord (see Glossary, page 105) until strap measures 12 (13)" (30.5 [33] cm) from pick-up. Place sts temporarily on a safety pin. Work strap for other front point in the same way. Pin straps to upper edge of back bodice, each strap centered between the placket and a side seam. Try on dress. Adjust length of straps by adding or removing rows to achieve the best fit. BO all sts for straps, and with yarn threaded on a tapestry needle, sew straps firmly in place to bodice back. With long tail at beg of each strap, sew through pick-up point several times to reinforce. Sew lower edge of button placket to top of horizontal lace panel. Weave in loose ends. With sewing needle and thread, sew on buttons. ∞

Double Rose Leaf

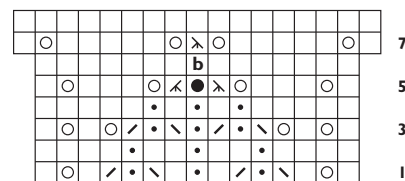

Lace Hem

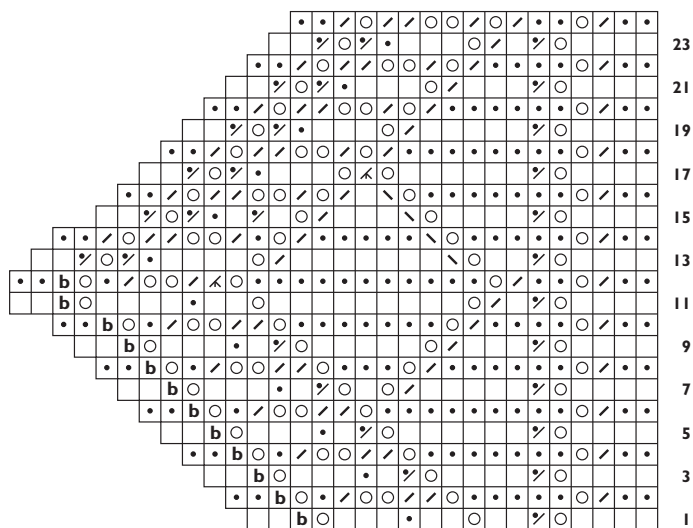

- k on RS; p on WS
- p on RS; k on WS
- / p2tog on RS; k2tog on WS
- \ k2tog on RS; p2tog on WS
- / \ k3tog on RS; p3tog on WS
- \ / ssk on RS; ssp on WS
- λ sl 1, k2tog, pssso on RS
- yo
- b k1 tbl
- bobble (omit on back skirt and bodice; see Stitch Guide)

MARI LYNN PATRICK designs and writes for the handknitting industry from her home in Baltimore, Maryland.

KnitCare

By  **Fairfield**

Allie's Bathing Suit

Materials: Blue Heron yarn - Water Hyacinth 8 oz., 425 yds.
#7 needles or size to get gauge

Gauge: 5-3/4 sts to 1" and 8-1/2 rows to 1"

Back: Cast on 13 stitches with waste yarn.

Row 1: K1, P1, K9, P1 K1.

Row 2: and All Even Rows: Purl.

Row 3: K1, P1, M1, knit to last 2 sts, M1, P1, K1.

Repeat these last two rows 11 times.

Row 26: P2, M1, purl to last 2 sts, M1, P2.

Row 27: Repeat Row 3.

Repeat these two rows 9 times.

Row 46: P2, M1, purl to last 2 sts, M1, P2.

Row 47: K1, P1, SSK, knit to last 4 sts, K2tog, P1, K1.

Row 48 & 50: Purl

Row 49: K1, P1, knit to last 2 sts, P1, K1.

Repeat these four rows three more times.

Knit four rows. Bind off loosely.

Front: Remove waste yarn and place 13 sts on needle.

Row 1: K1, P1, knit to last 2 sts, P1, K1.

Row 2 and all even rows: Purl.

Work these two rows until crotch is 3/4" long.

Refer to back directions and begin increase row.

Repeat every 4th row keeping in pattern for a

total of 9 increases. Then increase every other

row 5 times and every row 20 times. This

should measure 8 1/4" from crotch seam.

Refer to back directions and decrease

every 4th row a total of 4 times.

Decreases should be made on the knit

side. When piece measures 10 1/2",

decrease every row a total of 14 times,

then every other row two more times.

When piece measures 14 1/4" begin

increasing every row a total of 17 times.

Now work straight stockinette stitch for a

total of 4 rows. Decrease either side as before

every row 6 times. Stockinette stitch for 10 rows, then decrease

every other row 5 times. At the same time, when piece measures

18", work 4 stockinette rows. Keeping in pattern, bind off center 27

stitches and work each side separately. Continue in established

pattern and decrease 1 stitch each side every row 8 times.

Decrease as needed down to 4 stitches on each side. Work

I-cord for 12" or to desired length for neck ties. At side bust area

pick up 4 stitches and I-cord for 14" or to desired length for bust

ties. Sew sides of panty together and block lightly.



*For handbag pattern
visit our website at
www.poly-fil.com

Needle Cases

This perfect travel case is available in 2 sizes. These needle cases have a firm shell and a soft velvet lining.



Great for W.I.P.'s

Knit Wash

Gently washes delicate yarns.
48 washes per container



Knitter's Journal

Enough room to document
60 projects.



Allie Becky Jessie

Watch for future Fairfield ads to collect all six patterns by Monte Nikkel for the bathing suits and accessories featured above.

BED AND BATH DUO

design by MICKI HAIR

MICKI HAIR LIKES TO WORK WITH YARNS in natural fibers. For this feminine duo she's chosen velvety soft, undyed cottons and found several ways to highlight the yarns' quiet beauty. A simple knit-and-purl basketweave stitch adds comforting density to the fabric of the belted bathrobe, worked in plush organic cotton. Smooth stockinette stitch enhances the subtle sheen of the cotton used for the camisole-and-boxer pajamas. A simple I-cord motif stitched on at the finish of the bodice is all the adornment needed.

Finished Size Bathrobe: 44 (47, 49½)" (112 [119.5, 125.5] cm) bust/chest circumference, belted. Robe shown measures 44" (112 cm). Pajama top: 35 (37, 39)" (89 [94, 99] cm) chest/bust circumference. Top shown measures 35" (89 cm). Pajama bottoms: 38 (40, 42)" (96.5 [101.5, 106.5] cm) hip circumference. Bottoms shown measure 38" (96.5 cm).

Yarn Bathrobe: Blue Sky Alpacas 100% Organic Cotton (100% cotton; 150 yd [137 m]/100 g): #80 bones, 15 (17, 19) balls (used double). Pajamas: Heirloom 8-Ply Cotton (100% cotton; 130 yd [119 m]/50 g): #617 natural, 4 (4, 5) balls for top, 4 (4, 5) balls for bottoms. Yarn distributed by Russi Sales.

Needles Bathrobe—Size 11 (8 mm): straight and 32" (80-cm) cir. Adjust needle size if necessary to obtain the correct gauge. Pajamas—Size 6 (4 mm): straight, 24" (60-cm) circular (cir), and set of 2 double-pointed (dpp).

Notions Markers (m); stitch holders; tapestry needle; small amount of waste yarn or 2 safety pins for pajamas.

Gauge Bathrobe—12 sts and 16 rows = 4" (10 cm) in Blue Sky Alpacas cotton in basketweave patt with yarn doubled on size 11 (8 mm) needles. Pajamas—22 sts and 30 rows = 4" (10 cm) in Heirloom cotton worked in St st in the rnd on size 6 (4 mm) needles.

Stitch Guide

Raised Increases: *Right-slant:* Knit into the stitch below the next st on left needle, then knit the next st and slip it off the left needle as usual—1 st inc'd. *Left-slant:* Knit the next st, use the left needle tip to lift the loop 2 rows below the newly created st onto the left needle, then knit the lifted loop—1 st inc'd.

Ssk: Slip 3 sts individually knitwise, return these 3 sts to left needle, and knit them tog through their back loops—2 sts dec'd.

BASKETWEAVE ROBE

Notes

The fronts are worked separately from lower edge to shoulders, then joined by casting on across the back neck; the back is worked as one piece from shoulders down to lower edge.

Note what basketweave pattern row you end on for each front so you can resume working the pattern on the correct row for the back and keep the flow of the pattern continuous.

Left Front

With cir needle and yarn doubled, CO 46 (48, 50) sts. Do not

join into a rnd. Work garter st (knit every row) until piece measures 2" (5 cm) from beg, ending with a RS row. *Set up row:* (WS) K6 (front border; work in garter st throughout), place marker (pm), work set-up row of Basketweave chart (see page 30) over next 40 (42, 44) sts (beg and ending where indicated for your size). Keeping 6 marked sts for front border in garter st, rep Rows 1–8 of chart (do not rep set-up row) until piece measure 20 (23, 25)" (51 [58.5, 63.5] cm) from beg, ending with a WS row and removing marker for front border on last row. **Shape neck:** (RS) Work in patt to last 7 sts, k2tog, k5—1 st dec'd at neck edge. *Next row:* (WS) K6, work in patt to end. Cont in patt, rep the shaping of the last 2 rows 3 more times, ending with a WS row—42 (44, 46) sts; piece should measure about 22 (25, 27)" (56 [63.5, 68.5] cm) from beg. **Shape sleeves:** CO for sleeves as foll:

Row 1: (RS) Using the cable method (see Glossary, page 104), CO 14 (14, 16) sts, knit across new sts, work in patt to last 7 sts, k2tog, k5—55 (57, 61) sts.

Rows 2 and 4: (WS) K6, work to end, working new sts in basketweave patt.

Row 3: CO 14 (16, 16) sts, knit across new sts, work in patt to last 7 sts, k2tog, k5—68 (72, 76) sts.

Row 5: CO 6 sts, knit across new sts, work in patt to last 7 sts, k2tog, k5—73 (77, 81) sts.

Row 6: K6 (front border sts), work in patt to last 6 sts, k6 (cuff border; work in garter st throughout).

Keeping 6 sts at each end of needle in garter st, cont to dec 1 st at neck edge as before every RS row 15 more times, ending with a WS row—58 (62, 66) sts rem; piece should measure about 31 (34, 36)" (78.5 [86.5, 91.5] cm) from beg, ending with Row 1 or 5 of chart. Make a note of the last patt row completed. Place sts on holder.

Right Front

With cir needle and yarn doubled, CO 46 (48, 50) sts. Do not join into a rnd. Work garter st (knit every row) until piece measures 2" (5 cm) from beg, ending with a RS row. *Set-up row:* (WS) Work patt from Basketweave chart over next 40 (42, 44) sts (beg and ending where indicated for your size), pm, k6 (front border; work in garter st throughout). Keeping 6 marked sts for front border in garter st, work in basketweave patt until piece measures 20 (23, 25)" (51 [58.5, 63.5] cm) from beg, ending with a WS row and removing marker for front border on last row. **Shape neck:** (RS) K5, ssk, work in patt to end—1 st dec'd at neck edge.



Next row: (WS) Work in patt to last 6 sts, k6. Cont in patt, rep the shaping of the last 2 rows 2 more times, then work RS dec row once more—42 (44, 46) sts; piece should measure about 22 (25, 27)" (56 [63.5, 68.5] cm) from beg. **Shape sleeves:**

Row 1: (WS) Using the cable method, CO 14 (14, 16) sts, purl across new sts, work in patt to end—56 (58, 62) sts.

Row 2: (RS) K5, ssk, work in patt to end—55 (57, 61) sts.

Row 3: CO 14 (16, 16) sts, purl across new sts, work in patt to end—69 (73, 77) sts.

Row 4: Rep Row 2—68 (72, 76) sts.

Row 5: CO 6 sts, purl across new sts, work in patt to end—74 (78, 82) sts.

Row 6: K5, ssk, work in patt to last 6 sts, k6 (cuff border; work in garter st throughout)—73 (77, 81) sts.

Keeping 6 sts at each side in garter st, cont to dec 1 st at neck edge as before every RS row 15 more times, ending with the same WS patt row on which you ended for left front—58 (62, 66) sts rem; piece should measure about 31 (34, 36)" (78.5 [86.5, 91.5] cm) from beg.

Back

Return held left front sts to needle with RS facing. Cont in patt, work across 58 (62, 66) left front sts, use the backward loop method

(see Glossary, page 104) to CO 18 sts, work in patt across 58 (62, 66) right front sts—134 (142, 150) sts total. Next row: (WS) K6 (cuff), work in patt to last 6 sts of right front, pm, k6 right front border sts, k18 new CO sts, k6 left border sts, pm, work in patt to last 6 sts of left front, k6 (cuff). Work 6 rows even, working center 30 sts in garter st, and ending with a WS row—piece should measure about 2" (5 cm) from joining row. Next row: (RS) K6, work across all sts in patt to last 6 sts (removing markers as you come to them), k6. Work even in patt for 21 more rows, ending with a WS row—piece should measure about 7½" (19 cm) from joining row. **Shape sleeves:** BO 6 sts at beg of next 2 rows, then BO 14 (16, 16) sts at beg of foll 2 rows, then BO 14 (14, 16) sts at beg of foll 2 rows—66 (70, 74) sts rem. Mark each end of last row with waste yarn to indicate end of sleeve shaping. Work even in basketweave patt until piece measures 20 (23, 25)" (51 [58.5, 63.5] cm) from end of sleeve shaping. Work all sts in garter st for 2" (5 cm). BO all sts.

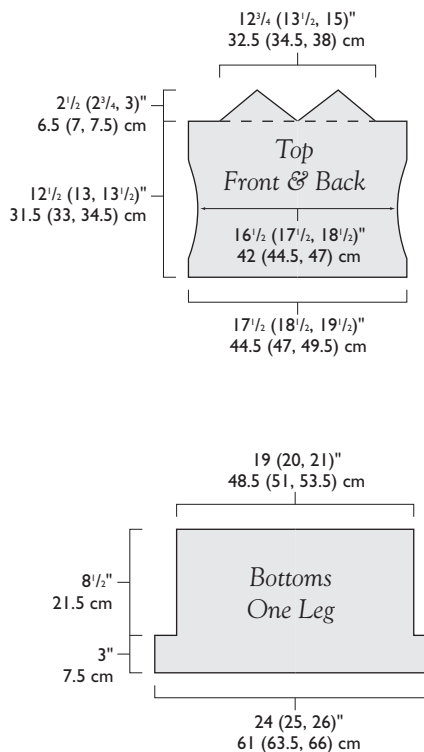
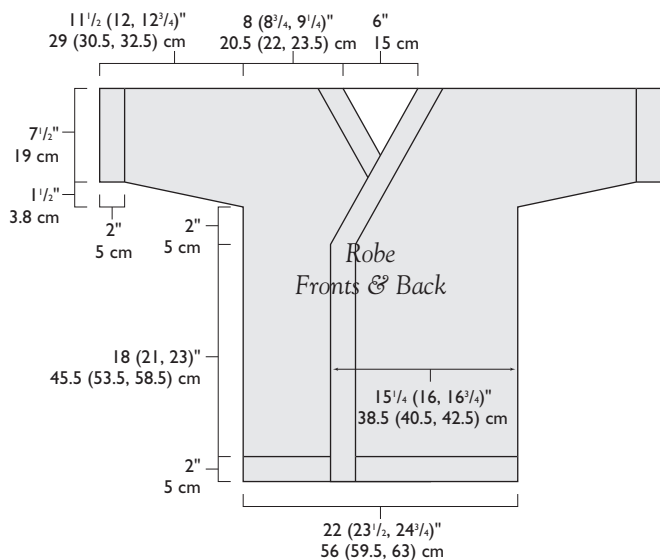

Basketweave

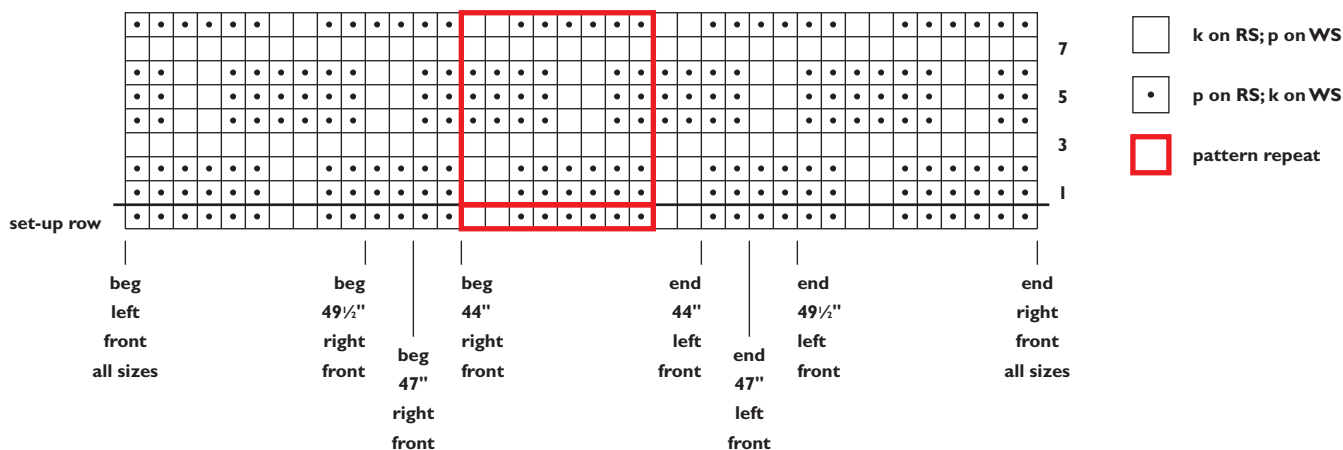

Tips & Techniques

FROM NICKY EPSTEIN

NICKY EPSTEIN *talks about* OTT-LITE® TRUECOLOR™ LIGHTING & KNITTING

by Gwen Bentley

Can a new tool help unlock the most creative regions of your imagination? Extend the amount of time you can spend on a project? Make your time spent knitting more pleasant and more comfortable?

OTT-LITE® TrueColor™ lighting offers a complete line of natural lighting products specifically designed for

artists, crafters,
and knitters to
match colors
accurately and
see details clearly
with reduced glare and
eyestrain. This unique
technology was created by
Dr. John Ott, the pioneer
of natural light science
who perfected time-lapse
photography with
Walt Disney.

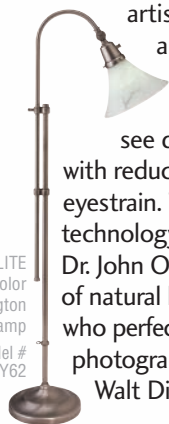

In fact, OTT-LITE Technology worked with physicians at Johns Hopkins Hospital in the development of light therapy for the treatment of Seasonal Affective Disorder (SAD) or “Winter Blues”.

Find out more as we interview knitwear designer, teacher and award-winning author, Nicky Epstein about OTT-LITE TrueColor lighting.

Gwen: What was your first reaction when you used OTT-LITE TrueColor lighting?

Nicky: Frankly, my first reaction was astonishment. It was **as if the sun had come indoors** (but without the glare or the suntan). My work took on a whole new clarity and I loved the look.

Gwen: How has OTT-LITE TrueColor lighting impacted your knitting?

Nicky: As a knitwear designer and author, the details of my work are very important to the finished look of the piece. If the details are right, the piece will be a success. **I was amazed how the OTT-LITE TrueColor lamp contributed to the details of my work**, bringing out the delineation of the stitches so clearly. It made my work more accurate and easier.

Gwen: What do you like most about OTT-LITE TrueColor lighting?

Nicky: The effect that the (OTT-LITE) light had on the texture and color of my yarns. The colors were not just brighter, but they looked richer and truer and allowed me to choose colors that really harmonized. **The (OTT-LITE) light heightened the yarn textures to help me create new subtleties in my designs.**

I also find that I can work longer designing and knitting because my eyes do not become as tired as they used to – making late-night knitting to meet a deadline, less of a problem.

Gwen: Would you recommend this lighting?

Nicky: **I would not only recommend the OTT-LITE lighting to my fellow knitters and students, but to anyone doing anything that requires indoor lighting.** I use it when I read or cook or just want a pleasant outdoor glow... indoors. And, the OTT-LITE lamps themselves have a great look that fits in anywhere.



Nicky Epstein
Knitwear Designer,
Teacher & Author

“OTT-LITE TrueColor lighting is a whole new way of looking at the world.”

Nicky's Tips

1 Add Embellishments to Any Piece!

Bobbles or popcorn stitches usually knit into the pattern, but they can be knitted separately and added to any knit piece by pulling the cast-on tail and bind-off tail to the wrong side and tying it. To hide the tails pull them through the bobble on the right side and cut. Use your OTT-LITE TrueColor lamp to make sure your embellishments complement your existing piece.

2 Speedy Knitting

For speedier knitting I keep my knit stitches very close to the needle tip. My right needle is anchored under my arm, which eliminates two movements for faster knitting and even more stitches. Good lighting from an OTT-LITE TrueColor lamp helps create a great environment to keep going.



For more information,
call 800-842-8848 or
visit www.ott-lite.com

Mention Ad Code IWK0504

OTT-LITE® and OTT-LITE Technology® are registered trademarks of Environmental Lighting Concepts, Inc.
© 2005 OTT-LITE Technology®

OTT-LITE products available at these and other fine stores:

ACMOORE
NO ONE DOES ARTS, CRAFTS & FLORALS BETTER™

Hancock Fabrics

HOBBY LOBBY

JO-ANN
experience the quality™

JOANN.COM™

Michaels
THE ARTS AND CRAFTS STORE

Finishing

Pin robe out and steam-block. With yarn threaded on a tapestry needle, sew side and sleeve seams. **Belt:** With yarn doubled, CO 8 sts. Work even in garter st until piece measures about 60" (152.5 cm), or desired length. BO all sts. **Belt loops:** (make 2) With yarn doubled, CO 3 sts, leaving a 6" (15-cm) tail for attaching loop to robe. Work in garter st until piece measures about 3" (7.5 cm) from beg. BO all sts, leaving a 6" (15-cm) tail. Try robe on and determine best location for belt loops (typically about 6" [15 cm] down from sleeve CO.) Using tails threaded on a tapestry needle, sew ends of each belt loop securely to side seam. Weave in loose ends.

PAJAMAS

Top

Lower body: With cir needle, CO 192 (204, 216) sts. Place marker (pm) and join for working in the rnd, being careful not to twist sts; rnd begins at center back. Knit 1 rnd. Purl 1 rnd. **Next rnd:** K48 (51, 54) for left back, pm for left side, k96 (102, 108) for front, pm for right side, k48 (51, 54) for right back. Work even in St st (knit every rnd) until piece measures 1½" (3.8 cm) from beg. **Dec rnd:** *Knit to 2 sts before side marker, ssk, slip marker (sl m), k2tog; rep from * once more, knit to end—4 sts dec'd. Work 9 (11, 11) rnds even. Rep the last 10 (12, 12) rnds 2 more times—180 (192, 204) sts rem; piece should measure about 5½ (6¼, 6¼)" (14 [16, 16] cm) from beg. **Inc rnd:** *Knit to 1 st before side marker, inc 1 st using left-slant raised inc (see Stitch Guide), sl m, inc 1 st using right-slant raised inc (see Stitch Guide); rep from * once more, knit to

end—4 sts inc'd. Work 9 (11, 11) rnds even. Rep the last 10 (12, 12) rnds 2 more times—192 (204, 216) sts; piece should measure about 9½ (11¼, 11¼)" (24 [28.5, 28.5] cm) from beg. Cont even until piece measures 12½ (13, 13½)" (31.5 [33, 34.5] cm) from beg. **Next rnd:** P61 (65, 67), k70 (74, 82), p61 (65, 67). **Divide for front and back:** BO 61 (65, 68) sts kwise for left back and armhole, knit until there are 70 (74, 82) sts on right needle for front, BO rem 61 (65, 67) sts kwise for right armhole and back, fasten off last st—70 (74, 82) sts rem for front. **Left front:** Place 35 (37, 41) sts for right half of front on holder. With RS facing, rejoin yarn at armhole edge of left front sts, ready to work a RS row. **Dec row:** *K2, sssk (see Stitch Guide), knit to last 5 sts, k3tog, k2—4 sts dec'd. Purl 1 WS row. Rep the last 2 rows 6 (6, 7) more times—7 (9, 9) sts rem. **Next row:** (RS) Ssk, knit to last 2 sts, k2tog—5 (7, 7) sts rem. Work 1 WS row even. **Next row:** K1 (2, 2), sl 1, k2tog, pssso, k1 (2, 2)—3 (5, 5) sts rem. Work 1 WS row even. For sizes 37" and 39" only, work 2 more rows, working sl 1, k2tog, pssso over center 3 sts of next RS row—3 sts rem for all sizes; front should measure about 2½ (2¾, 3)" (6.5 [7, 7.5] cm) from dividing rnd. **Strap:** Transfer 3 rem sts to dpn. Work 3-st I-cord (see Glossary, page 105) until strap measures 15" (38 cm) or desired length. Place sts on waste yarn or safety pin. **Right front:** Return held 35 (37, 41) held sts for right front to needle. Rejoin yarn with WS facing at armhole edge of right front sts, and purl 1 row. Beg with RS dec row, complete as for left front and strap—3 sts rem. Place strap sts on scrap yarn or safety pin.

ADRIENNE VITTADINI YARNS

Two new yarns for
Spring 2005
Bettina & Allegra





View entire collection at
www.handworksgallery.com
2911 Kavanaugh Blvd. ~ Little Rock, AR 72205
Toll Free (877) 614-1191

Preserve the Art



Hand Dyed
Rambling Rose Prism

50% SILK • 50% MERINO
625 YDS/SKEIN \$33.00



VISIT OUR WEBSITE • WWW.LAMBSPUN.COM
OR CALL 1-800-558-5262

Finishing

Lay top out flat with front side up. Pin the bottom edge straight and pin the top edge of fronts to shape, leaving the sides unpinned so they can curve as shaped. Spray lightly with water then steam-block with a hot iron. Let dry thoroughly. Turn top over and repeat with back side up, and allow to dry once more. Temporarily pin straps to upper edge of back about 3 (3½, 3¾)" (7.5 [9, 9.5] cm) on each side of center. Try on top and adjust length of straps by adding or removing rows to achieve the best fit. BO all sts for straps. With yarn threaded on a tapestry needle, sew strap ends firmly in place. Weave in loose ends. **Cords:** (make 2) With dpn, CO 3 sts. Work 3-st I-cord until piece measures 10 (11, 11)" (25.5 [28, 28] cm) from beg. BO all sts. **Bobbles:** (make 6) CO 1 st, leaving a 6" to 8" (15- to 20-cm) tail. Work (k1, p1, k1) all in same st, turn, p3, turn, k3, turn, p3tog—1 st. Fasten off. Coil cords to create decorative scrolls as shown in photograph and sew in place with yarn threaded on a tapestry needle. Attach bobbles as shown. Lightly steam-block again, taking care not to flatten the decorations, and let air dry.

Bottoms

Note: Each leg is worked separately back and forth in rows to the crotch, then joined for working in the round to the waist. **Legs:** (make 2) CO 132 (138, 144) sts. Do not join into a rnd. Knit 1 row. Purl 2 rows. Change to St st, and beg with a RS (knit) row, work even until piece measures 3" (7.5 cm) from beg, ending with a WS row. BO 14 sts at beg of next 2 rows—104 (110, 116) sts rem. Place sts on holder. Work second leg same as the first,



Selection, Service & Value...

That's what you'll find whether you visit WEBS' newly expanded 5000 square foot store in Northampton, Massachusetts or shop WEBS online at www.yarn.com.

WEBS is committed to providing our customers with the finest selection of yarns and fibers, backed by superior service, and always the best prices!

Shop WEBS today for all your knitting needs!

Save Up to
25% on Your
Next Purchase!
Visit www.yarn.com
for details.

800.367.9327 | www.yarn.com | 75 Service Center Rd., Northampton, MA



America's Yarn Store™



but do not cut off yarn. **Join legs:** Work across 104 (110, 116) leg sts on needle, return held sts to needle, and work across 104 (110, 116) sts for other leg—208 (220, 232) sts total. Place marker (pm) and join for working in the rnd; rnd begins at center back. Work even until piece measures 8" (20.5 cm) from joining rnd. **Eyelet rnd:** K0 (2, 0), *k2, k2tog, yo; rep from * to last 0 (2, 0) sts, k0 (2, 0)—52 (54, 58) eyelet holes completed. Knit 3 rnds, then purl 1 rnd. BO all sts kwise.

Finishing

Lay bottoms out flat, front side up. Pin the bottom and top edges straight, overlapping the leg extensions at the crotch as necessary, and leaving the sides unpinned. Spray lightly with water, then steam-block with a hot iron. Let dry thoroughly. Turn bottoms over, repeat with back side up, and allow to dry once more. With yarn threaded on a tapestry needle, sew inside leg seams. Sew across crotch seam. Weave in loose ends. **Drawstring:** With dpn, CO 3 sts. Work 3-st I-cord until piece measures 52" (132 cm) from beg or desired length. Fasten off. Beg and end at center front, thread drawstring through eyelets, and tie at center front. ∞

Instructions for a coordinating bath mitt (shown at left and knitted with cotton yarn from Henry's Attic) are available on our website: www.interweaveknits.com.

MICKI HAIR is a fiber enthusiast who knits, spins, dyes, and enjoys the country life with her husband in Johnston, South Carolina.

FOR THE LOVE OF YARN...♥♥♥

Henry's Attic, Inc.*

house of natural fiber yarns...

brought to you for
over three generations.

wholesale only*

to locate a Henry's Attic retailer
near you, please contact us.
phone: (845) 783.3930
fax: (845) 782.2548

illustration by star

COLOR ME... HANDPAINTED YARNS & FIBER

Captivating handpainted
yarns in
32 colorways



For Wholesale Inquiries
please call 877-783-1310

Visit our website for a
retail location nearest you

www.colormeyarn.com

Create a stir.

Susan Bates®
Crystalites™
Needles and Hooks
coatsandclark.com
© 2004 Coats & Clark



TWO-TIE STRIPED CARDIGAN

design by SUSAN MILLS

A RIBBED PATTERN WORKED in five sunny colors makes a close-fitting, breezy cardigan. The front edges are finished with a simple rolled edging, and knitted ties eliminate the need to measure and plan for buttonholes. As you work the stripes, take the time to carry the yarns not in use along the selvedge edge. Though carrying takes a little patience, in the long run you'll be glad you made the effort—when it's time to weave in the ends, you'll have only a few to deal with.

Finished Size 30½ (33, 35½, 38, 41, 43, 46)" (77.5 [84, 90, 96.5, 104, 109, 117] cm) bust/chest circumference, unstretched. Top shown measures 30½" (77.5 cm).

Yarn Reynolds Saucy Sport (100% mercerized cotton; 123 yd [112.5 m]/50 g): #545 coral reef (A), 3 balls (all sizes); #63 parakeet (B), #811 faded gold (C), #125 persimmon (D), and #558 sage (E), 2 (2, 2, 3, 3, 3, 3) balls each.

Needles Size 5 (3.75 mm). Adjust needle size if necessary to obtain the correct gauge.

Notions Stitch holder; markers (m); tapestry needle.

Gauge 25 sts and 33 rows = 4" (10 cm) in rib patt after blocking.

Stitch Guide

Stripe Sequence: (worked in rib patt)

Work 2 rows A, 2 rows B, 2 rows C, 4 rows D, 6 rows E, 2 rows D, 2 rows E, 2 rows A, 4 rows B, 6 rows C, 2 rows B, 2 rows C, 2 rows D, 4 rows E, 6 rows A, 2 rows E, 2 rows A, 2 rows B, 4 rows C, 6 rows D, 2 rows C, 2 rows D, 2 rows E, 4 rows A, 6 rows B. Repeat these 80 rows for pattern.

Note

Carry colors not in use along the side of the work, twisting them at color changes.

Back

With A, CO 95 (103, 111, 119, 127, 135, 143) sts. Beg with a WS row, work in rib patt and stripe sequence foll Back and Sleeve chart (see page 38) until piece measures 13" (33 cm) from beg. **Shape armhole:** Keeping in patt, BO 3 (3, 3, 4, 5, 6, 6) sts at the beg of next 4 rows, then BO 2 (2, 2, 3, 4, 4, 4) sts at the beg of foll 2 rows—79 (87, 95, 97, 99, 103, 111) sts rem. **Dec row:** (RS) Ssk, knit to last 2 sts, k2tog—2 sts dec'd. Work 1 WS row even. Rep the last 2 rows 3 (3, 4, 4, 5, 5, 5) more times—71 (79, 85, 87, 87, 91, 99) sts rem. Cont even in patt until armholes measure 8 (8½, 9, 9½, 9½, 10, 10)" (20.5 [21.5, 23, 24, 24, 25.5, 25.5] cm), ending with a WS row. **Shape neck and shoulders:** Mark center 25 sts. **Next row:** (RS) BO 5 (6, 7, 7, 7, 7, 9) sts, work to marked sts, place 25 center sts on holder, join new ball of yarn, BO 4 (5, 5, 5, 5, 5, 5) sts (neck edge), work to end. **Next row:** (WS) Working each side separately, BO 5 (6, 7, 7, 7, 7, 9) sts at beg of first set of sts, then BO 4 (5, 5, 5, 5, 5, 5) sts at beg of second set of sts—14 (16, 18, 19, 19, 21, 23) sts rem each side. Cont in patt, at each neck

edge BO 3 (3, 3, 4, 4, 5, 5) sts once; at each armhole edge, BO 5 (6, 7, 7, 7, 8, 9) sts once, then BO rem 6 (7, 8, 8, 8, 8, 9) sts.

Right Front

With A, CO 48 (51, 56, 59, 64, 67, 72) sts. Beg with a WS row, work in stripe sequence and rib patt according to Right Front chart, beg and end as indicated for your size, until piece measures 13" (33 cm) from beg, ending with a RS row. **Shape armhole:** (WS) Cont in patt, at armhole edge (beg of WS rows), BO 3 (3, 3, 4, 5, 6, 6) sts 2 times, then BO 2 (2, 2, 3, 4, 4, 4) sts once—40 (43, 48, 48, 50, 51, 56) sts rem. **Dec row:** (RS) Work even in patt to last 3 sts, ssk, k1—1 st dec'd. Dec 1 st at armhole edge in this manner every RS row 3 (3, 4, 4, 5, 5, 5) more times—36 (39, 43, 43, 44, 45, 50) sts. Work even until armhole measures 6½ (7, 7½, 8, 8, 8½, 8½)" (16.5 [18, 19, 20.5, 20.5, 21.5, 21.5] cm). **Shape neck and shoulder:** At neck edge (beg of RS rows), BO 6 (6, 6, 6, 7, 7, 7) sts once, then BO 5 (5, 5, 5, 5, 5, 6) sts once, then BO 4 sts once, then BO 2 (2, 3, 3, 3, 3, 3) sts once. Dec 1 st at neck edge (k1, k2tog, work to end) 3 times. *At the same time*, when piece measures same as back to shoulder, shape shoulder as foll: At armhole edge (beg of WS rows), BO 5 (6, 7, 7, 7, 7, 9) sts once, then BO 5 (6, 7, 7, 7, 8, 9) sts once, then BO rem 6 (7, 8, 8, 8, 8, 9) sts.

Left Front

Work as for right front but work armhole and shoulder shaping at beg of RS rows and BO for neck at beg of WS rows, then work neck shaping as ssk at end of RS rows.

Sleeve

With A, CO 63 (63, 63, 71, 71, 71, 71) sts. Beg with a WS row, work in stripe sequence and rib patt according to Back and Sleeve chart until piece measures 3½" (9 cm) from beg, ending with a WS row. **Dec row:** (RS) K1, k2tog, work in patt to last 3 sts, ssk, k1—2 sts dec'd. Work 5 (5, 5, 3, 3, 3, 3) rows even. Rep the last 6 (6, 6, 4, 4, 4, 4) rows 3 (3, 3, 4, 4, 4, 4) more times—55 (55, 55, 61, 61, 61, 61) sts rem. Work even until sleeve measures 8" (20.5 cm) from beg, ending with a WS row. **Inc row:** (RS) K1, M1 (see Glossary, page 105), work in patt to last st, M1, k1—2 sts inc'd. Inc 1 st each end of needle in this manner every 2nd row 0 (1, 4, 1, 4, 6, 7) more time(s), then every 4th row 1 (4, 4, 4, 4, 5, 5) time(s), then every 8th row 6 (5, 4, 5, 4, 3, 3) times—71 (77, 81, 83, 87, 91, 93) sts. Work even until piece measures

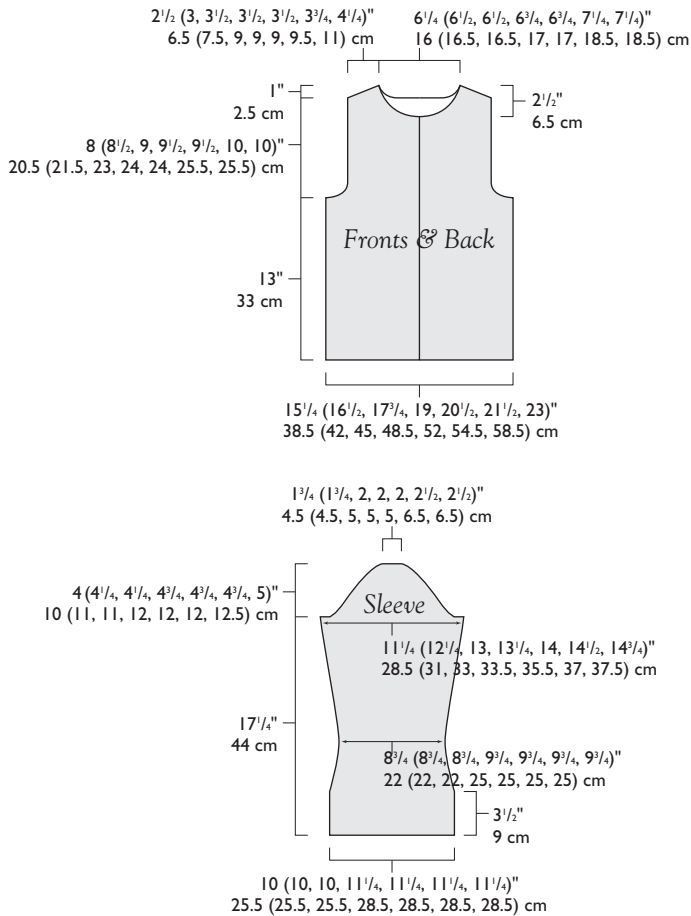

17 1/4" (44 cm) from beg, ending with a WS row. **Shape cap:** BO 5 (5, 6, 5, 5, 6, 6) sts at the beg of the next 2 rows—61 (67, 69, 73, 77, 79, 81) sts rem. **Dec row:** K1, ssk, work to last 3 sts, k2tog, k1—2 sts dec'd. Work 1 WS row even. Rep the last 2 rows 10 (12, 12, 14, 13, 13, 15) more times—39 (41, 43, 43, 49, 51, 49) sts rem. BO 2 sts at beg of next 2 rows, then BO 3 sts at beg of foll 2 rows, then BO 4 sts at beg of foll 2 rows, then BO 5 (6, 6, 6, 4, 5, 4) sts at beg of foll 2 rows, then BO 0 (0, 0, 0, 5, 4, 4) sts at beg of foll 2 rows—11 (11, 13, 13, 13, 15, 15) sts rem. BO all sts.

Finishing

Wet-block or steam all pieces to measurements. With yarn threaded on a tapestry needle, sew shoulder seams. With A and RS facing, pick up and knit 32 sts along right front neck, knit 25 held back neck sts, pick up and knit 32 sts along left front neck—89 sts total.

Row 1: Knit to end, use the backward loop method (see Glossary, page 104) to CO 40 sts for tie—129 sts.

Row 2: BO 40 sts, knit to end, use the backward loop method to CO 40 sts.

Row 3: BO 40 sts, knit to end—89 sts rem.

BO all sts. **Left front band:** Measure 3" (7.5 cm) down from top at center front and mark for tie. With A and RS facing, pick up and knit 104 sts evenly spaced along left front. Knit 3 rows. **Next row:** (RS) BO to tie marker, use the backward loop method to CO 40 sts onto RH needle, turn work, use a spare needle to BO the 40 sts just CO—1 st on right needle. Turn work, BO rem sts. **Right front band:** Work as for left front band. Sew small seams between top of front bands and side of top tie. Weave in loose ends.

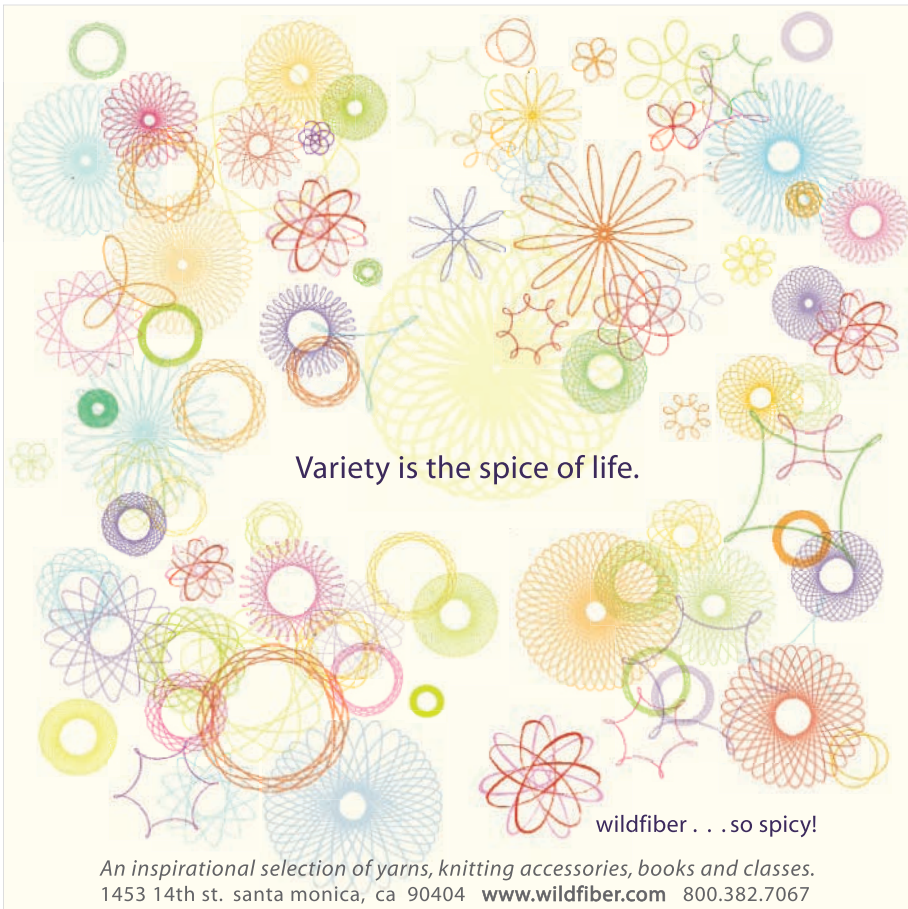

Left Front

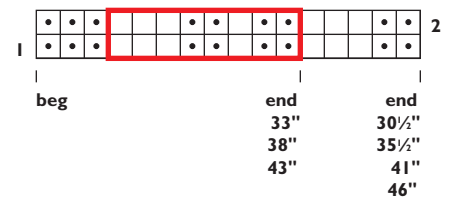

Right Front

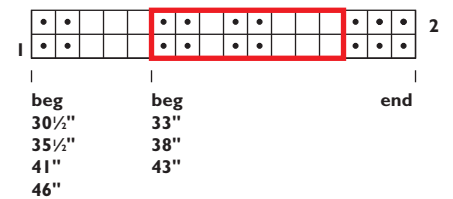

Back and Sleeve

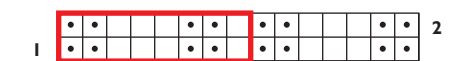

- k on RS; p on WS
- pattern repeat
- p on RS; k on WS

SUSAN MILLS lives and works in Townsend, Massachusetts, where she is the director of knitting yarns for JCA, Inc.

"Consuela"
Mohair
Poncho
Very quick knit

fresh fast & fun

"Polly" Tee
In Euroflax
Geneva Worsted
Wt. Linen



"Tess" Camisole
In Euroflax
Geneva Worsted
Wt. Linen



Available at these stores...

- AK ANCHORAGE /Knitting Frenzy/ 907-563-2717
- AK FAIRBANKS /INUA Wool Shoppe/ 907-479-5830
- AR BENTONVILLE /Morning Glory Yarn & Fiber/ 479-254-0611
- AZ MESA /The Fiber Factory/ 480-969-4346
- CA LOS ANGELES /Black Sheep Knittery/ 323-464-2253
- CA SANTA MONICA /Wildfiber/ 310-458-2748
- CO BOULDER /Shuttles, Spindles & Skeins/ 303-494-1071
- CO ELIZABETH /The Red Wheel/ 303-646-0800
- FL WINTER PARK /Sip & Knit/ 407-622-5648
- ID BOISE /The Thread Gatherer/ 208-387-2641
- IL CHICAGO /Arcadia Knitting/ 773-293-1211
- IL SPRINGFIELD /Knit Wits/ 217-698-6100
- IN INDIANAPOLIS /Mass Ave Knit Shop/ 317-638-1833
- IN MORGANTOWN /Sheep Street Fibers/ 812-597-5648
- IN WOLCOTTVILLE /Knitting Today/ 260-351-2260
- MA CAMBRIDGE /Woolcott & Co./ 617-547-2837
- MD CHESAPEAKE CITY /Vulcan's Rest/ 410-885-2890
- MI ANN ARBOR /Knit a Round Yarn Shop/ 734-998-3771
- MN MOORHEAD /Pieces of String/ 218-233-6670

- MN MINNEAPOLIS /Clickity Sticks Yarns & Such/ 612-724-2500
 - MN MINNEAPOLIS /Needlework Unlimited/ 612-925-2454
 - MN MINNEAPOLIS /Creative Fibers/ 612-927-8307
 - MN ST. PAUL /The Yarnery/ 651-222-5793
 - MN ST. PAUL /Three Kitten Yarn Shoppe/ 651-457-4969
 - NC ASHEVILLE /Earth Guild/ 828-255-7818
 - NC FLETCHER /Sage Cottage Yarns/ 828-684-0770
 - NH ANTRIM /The Wool Room/ 603-588-6637
 - NH CENTER HARBOR /Keepsake Quilting Inc./ 603-253-8148
 - NV LAS VEGAS /Wooly Wonders/ 702-547-1661
 - NY PATTERSONVILLE /A Touch of Twist/ 518-864-5885
 - NY NEW YORK /Seaport Yarn/ 212-608-3100
 - OH AVON /French Creek Fiber Arts/ 440-934-1236
 - OR LAKE OSWEGO /Molehill Farm/ 503-697-9554
 - OR COOS BAY /My Yarn Shop/ 541-266-8230
 - PA EAST BERLIN /Mannings Creative Crafts/ 717-624-2223
 - TN MEMPHIS /Rainbow Yarn & Fibers/ 901-753-9835
 - TX HOUSTON /Yarns 2 Ewe/ 713-880-5648
 - VA AMISSVILLE /Misty Mountain Farm/ 540-937-4707
 - VA ALEXANDRIA /Spring Water Workshop/ 703-549-3634
 - WA BOTHELL /Columbine Yarn/ 425-806-8129
 - WI MADISON /Lakeside Fibers/ 608-257-2999
- CANADA:
- MB WINNIPEG /Ram Wools/ 204-949-6868
 - ON BLOOMFIELD /Yarn Source/ 613-393-2899
 - ON CARP /Yarn Forward Inc./ 613-831-9673
 - ON WATERLOO /Cloth & Clay/ 519-886-7400
 - QC POINTE CLAIRE /Toisons de Ville/ 800-695-7838



Samples: \$10.00 per set
Contact: **Louet Sales**
808 Commerce Park Dr.
Station KN Ogdensburg,
NY 13669
or in Canada: 3425 Hands
Rd. Prescott, ON K0E 1T0
www.louet.com
info@louet.com

VIENNESE SHRUG

design by LISA DAEHLIN

THERE ARE REWARDS to working a favorite lace pattern in a worsted-weight yarn: The pattern grows quickly before your eyes, and the larger-than-usual motifs add drama to an otherwise understated garment. Lisa Daehlin's lacy shrug showcases a warm, shoulder-cuddling merino. Each half of the shrug is worked on two needles from the center back to midsleeve, then joined and worked in the round for ribbed cuffs. Take care to block the pieces gently to preserve the dimensional effect of the leaf motifs.

Finished Size 19½" (49.5 cm) wide at center back and 45" (114.5 cm) long from cuff to cuff.

Yarn Morehouse Farms Merino 2-Strand (100% wool; 220 yd [201 m]/2 oz): raspberry, 4 skeins.

Needles Body and Sleeves—Size 7 (4.5 mm): 24" (60-cm) circular (cir) and set of 4 double-pointed (dpn). Cuffs—Size 6 (4 mm) and size 4 (3.5 mm): set of 4 dpn. Adjust needle size if necessary to obtain the correct gauge.

Notions A few yards (meters) of waste yarn for provisional cast-on; markers (m); removable stitch markers or safety pins (optional); tapestry needle.

Gauge 17 to 31 sts (one patt rep) = 4" (10 cm) wide and 40 rows = 5¼" (13.5 cm) high in leaf spray patt from chart on larger needles.

Stitch Guide

Seed Stitch: (odd number of sts)

All Rows: *K1, p1; rep from * to last st, k1.

Repeat this row for pattern.

Notes

Each half of the shrug begins at the center back and is worked back and forth in rows to the beginning of the sleeve, where the piece is joined for working in the round. When working in the round, read all chart rounds from right to left as for right-side rows.

The Leaf Spray pattern repeat fluctuates between 17 and 31 stitches per repeat. This allows the large leaf elements of the design to puff out for a 3-dimensional effect. The center stitch in each repeat should remain aligned from row to row, and is indicated in yellow on the charts. You may find it helpful to mark each center stitch with a removable marker or safety pin to make sure that your pattern rows line up correctly.

On the row or round following a double yarnover, work the double yarnover as k1 in first loop of yo, p1 in second loop of yo, as shown on chart.

Left Half

With larger needle and using a provisional method (see Glossary, page 105), CO 110 sts. Establish patts as foll: (RS) Work 9 sts in seed st (see Stitch Guide), place marker (pm), work Row 1 of Leaf Spray chart (see page 42) 4 times, pm, work 9 sts in seed st—126 sts; center 92 sts inc'd to 108 sts; 27 sts in each patt rep after completing Row 1. *Note:* After completing the first patt rep

in each half of shrug, rep *only* Rows 3–42 of chart; do not work Rows 1 and 2 again. Working center sts according to Leaf Spray chart and, maintaining 9 sts at each side in seed st, work Rows 2–42 to complete the first rep of chart. Then work Rows 3–42 once, then work Rows 3–12 once—86 sts; 17 sts in each patt rep; 92 patt rows completed; piece should measure about 12" (30.5 cm) from beg. **Shape neck and dec seed st borders:** The first patt rep at beg of RS rows will be gradually dec'd away to provide shaping at neck edge. *At the same time*, the seed st borders at both sides will also be dec'd away and the sleeve changes to being worked in the rnd. Cont as foll:

Row 13: (RS) Work 7 sts in seed st, k2tog, sl m, work Row 13 of Decrease chart over next 17 sts, work 3 full reps of Leaf Spray chart Row 13 as established, sl m, ssk, work 7 sts in seed st—88 sts; 15 sts in first rep (the one worked according to Decrease chart); 19 sts in each of 3 full patt reps; 8 sts in each seed st border.

Row 14 and all even-numbered rows through Row 18: Work even in patts.

Row 15: Work 6 sts in seed st, k2tog, sl m, work Row 15 of Decrease chart over next 15 sts, work 3 full reps of Leaf Spray chart Row 15 as established, sl m, ssk, work 6 sts in seed st—90 sts; 13 sts in first rep; 21 sts in each of 3 full patt reps; 7 sts in each seed st border.

Row 17: Work 5 sts in seed st, k2tog, sl m, work Row 17 of Decrease chart over next 13 sts, work 3 full reps of Leaf Spray chart Row 17 as established, sl m, ssk, work 5 sts in seed st—92 sts; 11 sts in first rep; 23 sts in each of 3 full patt reps; 6 sts in each seed st border.

Row 19: Work 4 sts in seed st, k2tog, sl m, work Row 19 of Decrease chart over next 11 sts, work 3 full reps of Leaf Spray chart Row 19 as established, sl m, ssk, work 4 sts in seed st—72 sts rem; 5 sts in first rep; 19 sts in each of 3 full patt reps; 5 sts in each seed st border.

Join for sleeve:

Row/Rnd 20: Work in patts as established, pm, and join for working in the rnd at end of row, transferring to larger dpn if necessary. From this point on, work WS rows of chart as RS rnds.

Rnd 21: Work 3 sts in seed st, k2tog, sl m, work Row 21 of Decrease chart over next 5 sts, work 3 full reps of Leaf Spray chart Row 21 as established, sl m, ssk, work 3 sts in seed st—68 sts rem; 3 sts in first rep; 19 sts in each of 3 full patt reps; 4 seed sts at each end of rnd.



Rnd 22: Work even in patts.

Rnd 23: Work 2 sts in seed st, k2tog, sl m, work Row 23 of Decrease chart over next 3 sts, work 3 full reps of Leaf Spray chart Row 23 as established, sl m, ssk, work 2 sts in seed st—82 sts; 1 st in first rep; 25 sts in each of 3 full patt reps; 3 seed sts at each end of rnd.

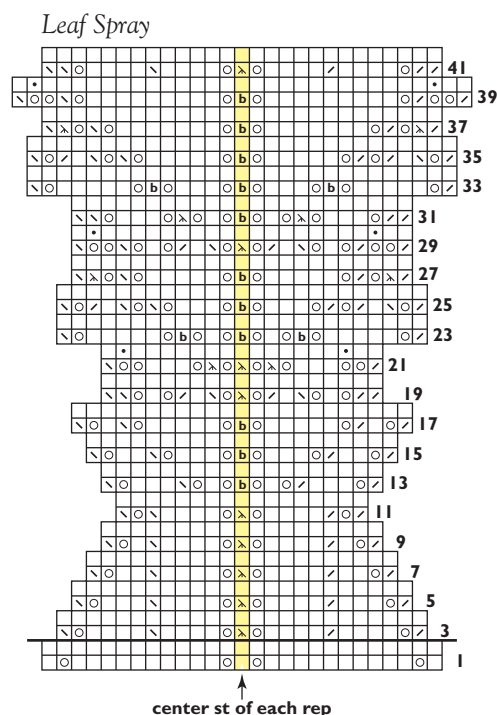

Rnd 24: Work even in patts, removing seed st border markers.

Rnd 25: Work 1 st in seed st, (sl 1, k2tog, pss0) to dec 1 st from seed st border and eliminate rem st of Decrease chart, work 3 full reps of chart Row 25 as established, sl m, ssk, work 1 st in seed st—79 sts rem; 25 sts in each of 3 full patt reps; 2 seed sts at each end of rnd.

Rnd 26: Work even in patts.

Rnd 27: K2tog, work 3 full patt reps of chart Rnd 27 as established, ssk—71 sts; 23 sts in each of 3 full patt reps; 1 seed st at each end of rnd.

Rnd 28: K2tog, work in patt to last 2 sts, ssk—69 sts rem; only 3 full patt reps rem. Cont in the rnd, work Rnds 29–42 of chart. Change to medium-sized dpns and work Rnds 3–23 once more—75 sts; 143 chart rows completed; piece should measure about 18½" (47 cm) from beg. **Cuff:** Knit 1 rnd, dec 27 sts evenly spaced—48 sts rem. Change to smallest dpn, and work in k1, p1 rib for 4" (10 cm)—piece should measure about 22½" (57 cm) from beg. BO all sts loosely in rib.

Right Half

Remove waste yarn from provisional CO and place live sts on larger needle. Work as for left half to beg of neck shaping—86 sts; 17 sts in each patt rep; 92 patt rows completed; piece should measure about 12" (30.5 cm) from beg. **Shape neck and dec seed st borders:** The last patt rep at end of RS rows will be gradually dec'd away to reverse the neck shaping. Set up patts to reverse shaping as foll:

Row 13: (RS) Work 7 sts in seed st, k2tog, slip marker (sl m), work 3 full reps of Leaf Spray chart Row 13 as established, work Row 13 of Decrease chart over next 17 sts, sl m, ssk, work 7 sts in seed st—88 sts; 19 sts in each of 3 full patt reps; 15 sts in last rep (the one worked according to Decrease chart); 8 sts in each seed st border.

Cont as for left half, dec seed st border and working the Decrease chart over patt rep at end of RS rows, until Row 19 has been completed. Join for working sleeve in the rnd, and complete as for left half.

Finishing

Weave in loose ends. Block lightly to preserve the 3-dimensional effect of the leaves. ∞

Plassard

SINCE 1886

LASER: This sparkly and attractive yarn is available in 8 "fashion right" colors and is just one of 29 patterns appearing in our spring/summer catalog #40.

To locate your nearest store, visit our website www.plassardyarnsusa.com, or call toll-free 1-866-341-9425, or e-mail plassardyarns@aol.com

Brookman Imports
4911 Lyons Tech Pkwy.
Coconut Creek, FL 33073



No. 40/10: Bilbao

LISA DAEHLIN sings opera and knits in New York City.



Colinette

YARNS

www.colinette.com

An explosive new yarn from Colinette

FireCracker



Introducing
take 5
 knitwear series

A knitwear series for
1824 wool

Look for the first Take5 book...
 "Closure" jackets

Mission Falls

Detail of "Bohemia" from the pattern collection Closure

Inspirational Fibers for Passionate Knitters!

For your nearest Colinette or Mission Falls retailer in the United States, please call Unique Kolours at (800)-25-2DYE4 or visit us online.

www.uniquekolours.com

PADDED FOOTLETS

design by MARY SNYDER

INDULGE YOUR FEET with Mary Snyder's short socks knitted with a double thickness of yarn to cushion the soles. The padding is worked in a sequence of two rounds that uses two strands of yarn for the sole stitches and a single strand for the instep. The transition between the padded sole and single-thickness instep is cleverly concealed along a column of purl stitches. Little touches—a lace panel on the instep that's repeated on the heel flap, ankle-hugging ribbing, and a trim accent stripe on the cuff—add to the appeal.

Finished Size About 7" (18 cm) circumference at ball of foot, unstretched, and 8" (20.5 cm) circumference comfortably stretched; about 10" (25.5 cm) long from back of heel to toe. To fit women's U.S. shoe sizes 7–10.

Yarn Gems Pearl (100% superwash merino; 185 [169 m]/50 g): #50 sage (MC), 2 skeins, and #02 tobacco (CC), 1 skein. Yarn distributed by Louet.

Needles Size 0 (2 mm): set of 5 double-pointed (dpn). Adjust needle size if necessary to obtain the correct gauge.

Notions Marker (m); tapestry needle.

Gauge 14 sts and 22 rows = 2" (5 cm) in St st, worked in the round.

Stitch Guide

Wrap next stitch, turn: With yarn in front, slip the next stitch as if to purl, bring yarn to back, and turn work. On the following row, slip the wrapped stitch as if to purl with yarn in front.

Note

When working the heel flap and turning the heel, slip the first st as if to knit with yarn in back on both RS and WS rows.

Leg

Cuff: With MC and using the long-tail method (see Glossary, page 104), CO 58 sts. Arrange sts on 4 dpn, place marker (pm), and join for working in the rnd. With MC and beg with p1, work p1, k1 rib for 2 rnds. With CC, knit 1 rnd, then work 1 rnd p1, k1 rib as before. Cut off CC. Cont with MC only, knit 1 rnd, then work p1, k1 rib for 6 rnds. **Shape back of ankle:** Work back and forth in short rows (see Glossary, page 105) as foll:

Row 1: (RS) [P1, k1] 14 times, wrap next st, turn (see Stitch Guide).

Row 2: (WS) Sl 1 (wrapped st) pwise, [p1, k1] 13 times, p1, wrap next st (first st of original rnds), turn.

Row 3: Sl 1 pwise, [k1, p1] 13 times, wrap next st, turn.

Row 4: Sl 1 pwise, [k1, p1] 12 times, k1, wrap next st (second st of original rnds), turn.

Row 5: Sl 1 pwise, [p1, k1] 12 times, p1, pick up and knit the next wrap tog with the previously slipped knit st, pick

up and purl the foll wrap tog with the previously slipped purl st, then work established rib to end-of-rnd marker (m)—2 wrapped sts rem at beg of next rnd, after marker.

Heel

Heel flap: Work heel flap back and forth in rows on the first 29 sts as foll: **Set-up Row:** Pick up and knit the next wrap tog with the previously slipped purl st, pick up and knit the foll wrap tog with the previously slipped knit st, k3, k2tog, k1, yo, p1, k11, p1, yo, k1, ssk, k4, p1—29 sts. Turn. Change to Heel Flap chart (see page 46) and work Rows 2–10 once (set-up rnd counts as Row 1 of first patt rep), then work Rows 1–10 once, then work Rows 1–9 once more. Join a second strand of MC. **Next row:** (WS) With 2 strands held tog, sl 1 kwise, p28. **Next row:** Sl 1 kwise, k27, p1. Rep the last 2 rows 2 more times. **Turn heel:**

Cont with yarn doubled, work short rows as foll:

Row 1: (RS) Sl 1 kwise, k16, ssk, p1, turn.

Row 2: Sl 1 kwise, p6, p2tog, p1, turn.

Row 3: Sl 1 kwise, k7, ssk, p1, turn.

Row 4: Sl 1 kwise, p8, p2tog, p1, turn.

Cont in this manner, working 1 more st before dec until every st has been worked, ending with a WS row—17 sts rem.

Foot

Gusset: Establish instep gussets, lace instep panel, and padded sole as foll:

Rnd 1: Cont with yarn doubled, sl 1 kwise, k16, pick up and knit 1 st in each of the next 5 selvedge sts of heel flap, drop one strand to the inside of the sock, cont with a single strand of yarn and pick up and knit 14 more sts along side heel flap to beg of instep sts, pm, work 29 instep sts according to Rnd 1 of Instep chart, pm, pick up and knit 14 sts along side of heel flap, pm, pick up and knit 5 more sts along heel flap, ending at beg of heel sts—84 sts total. Rearrange sts so first 22 and last 5 sts of rnd are on the first needle for sole (27 sole sts total), 14 sts each on 2 needles for gussets, and 29 sts on single needle for instep. Working yarn is between the 5th and 6th sts on the sole needle.





eleven more times, redistributing sts as necessary when number of sts becomes too few to grip needles securely, and ending with Rnd 1 of chart—60 sts rem; 27 sole sts, 29 instep sts, 2 knit sts for each gusset; 49 chart rnds completed to end with Rnd 1 of Instep chart. Cont instep sts in patt from chart, work Rnd 2 once more, working gusset decs as k2tog over 2 sts of first gusset, and ssk over 2 sts of second gusset—58 sts; 27 sole sts, 29 instep sts, 1 knit st for each gusset. Redistribute sts again, if desired, and rep Rnds 3 and 4 until Instep chart has been worked 5 times total, ending with Rnd 12 of Instep chart and Rnd 4 of padded sole patt—foot measures about 8" (20.5 cm) from back of heel. For a longer foot, rep Rnds 3 and 4 of padded sole, working instep sts in St st, until foot measures 2" (5 cm) shorter than desired total length, ending with Rnd 4.

Toe

Cont working padding on sole sts only, working the first and last sole sts and sts for the top of toe with a single strand of yarn.

Rnd 1: With MC, k1 with single strand, cont with double strand, knit to last sole st, drop one strand to inside of work, cont with single strand, knit last sole st, knit to end.

Rnd 2: With single strand of CC, k1, *sl 1 pwise wyb, k1; rep from * to last 2 sole sts, sl 1 pwise wyb, k1, drop CC working yarn, turn. WS facing, join a new strand of CC and cont as foll: *Sl 1 pwise wyf, p1; rep from * to last st of sole needle, drop working strand to outside of work, sl 1 pwise, turn. With RS facing skip to the end of the sole needle without working the sole sts again, pick up the single strand of CC dropped there, and knit to end; both strands of yarn are at end of rnd.

Rnd 3: With CC, rep Rnd 1.

Rnd 4: With single strand of CC, k1, *sl 1 pwise wyb, k1; rep from * to last 2 sole sts, sl 1 pwise wyb, k1, drop CC working yarn, turn. WS facing, pick up strand of CC dropped on previous row and cont as foll: *Sl 1 pwise wyf, p1; rep from * to last sole st, drop working strand to outside of work, sl 1 pwise, turn. With RS facing skip to the end of the sole needle without working the sole sts again, pick up the single strand of CC dropped there, and knit to end; both strands of yarn are at end of rnd. Cut CC and cont with MC to end.

Rnd 5: Rep Rnd 1.

Rnd 6: With MC, rep Rnd 2, dec 4 sts as foll: On sole sts work k1, ssk, work in patt to last 3 sole sts, k2tog, k1; on top of toe sts work k1, ssk, knit to last 3 top of toe sts, k2tog, k1—4 sts dec'd.

Rnds 7–22: Rep Rnds 3 and 4 with MC, dec 4 sts as in Rnd 6 on Rnds 10, 13, 16, 18, 20, 21, and 22—26 sts.

Cut yarn, leaving a 20" (51-cm) tail.

Finishing

Divide sts evenly on two needles. With yarn threaded on a tapestry needle and using the Kitchener st (see Glossary, page 105), graft rem sts tog. Weave in loose ends. Block lightly. ∞

MARY SNYDER'S background is designing rocket and satellite communication systems, but her passion is knitting, spinning, and making fine silver tools and accessories for knitters and spinners. Visit Mary's website at www.MarySnyderDesign.com.

REYNOLDS®

SAUCY

Start the summer
knitting our
SAUCY
shell twin set

Our versatile
worsted weight
mercerized cotton
comes in 47
luscious colors



Available at yarn stores everywhere or send \$5.00 for pattern #82300 shown here to:

Reynolds Yarn Dept. IKSM05 35 Scales Lane Townsend, MA 01469-1094



SKETCHBOOK COVER



POLKA-DOT BAG

great gifts

IT'S ALWAYS A GOOD IDEA to have a knitted gift or two in the works. Here are four unusual projects that you will enjoy making and, if you can bring yourself to part with your achievements, will enjoy giving.

SKETCHBOOK COVER Véronik Avery

A TWO-COLOR PANEL WORKED IN A WAVY open-worked stitch pattern forms a decorative overlay for Véronik Avery's sketchbook cover. The cover slips over a standard 6" x 8" sketchbook and incorporates a pocket on the inside to house drawing pencils. Twisted cord ties keep the cover in place.

Finished Size About 12½" (31.5 cm) wide and 8" (20.5 cm) tall. To fit a 6" x 8" (15 x 20.5 cm) notebook with wire binding at top.

Yarn Rowan Lurex Shimmer (80% viscose, 20% polyester; 104 yd [95 m]/25 g): #337 minty (aqua metallic; A), 1 ball.



Joe Cocha

LACY KERCHIEF SCARF



TRIADA SCARF

Rowan Rowanspun 4 Ply (100% pure new wool; 162 yd [148 m]/25 g): #726 Hansel (medium green; B), 1 ball.

Rowan Yorkshire Tweed 4 Ply (100% pure new wool; 120 yd [110 m]/25 g): #286 graze (dark green; C), 3 balls.

Yarns distributed by Westminster Fibers.

Needles Size 2 (2.75 mm). Adjust needle size if necessary to obtain the correct gauge.

Notions Tapestry needle; size C/2 (2.75 mm) crochet hook; sewing pins; two pieces of cardboard, each 6" × 3½" (15 × 9 cm) for stiffening top half of cover (optional).

Gauge 31 sts and 36 rows = 4" (10 cm) in rev St st with Yorkshire Tweed 4 Ply (C).

Stitch Guide

Seed Stitch: (even number of sts)

Row 1: (RS) *K1, p1; rep from *.

Row 2: *P1, k1; rep from *.

Repeat Rows 1 and 2 for pattern.

Overlay

Strip 1: (make 5) With A and using the long-tail method (see Glossary, page 104), CO 68 sts. Work garter st (knit every row) for 4 rows (2 garter ridges). Cut yarn and change to B. Purl 1 row. Work 4 rows as foll:

Rows 1 and 3: (RS) K1, *k1, [k2tog, k2] 2 times, (k1, yo, k1) all

in next st, k2, (k1, yo, k1) all in next st, [k2, ssk] 2 times, k1; rep from * to last st, k1.

Row 2: Purl.

Row 4: Knit.

BO all sts as foll: *P2tog, return st on right needle to left needle; rep from * until all sts have been BO.

Strip 2: (make 5) With A and using the long-tail method, CO 68 sts. Knit 1 row. Cont as foll:

Row 1: (RS) K1, *k1, (k1, yo, k1) all in next st, k2, [ssk, k2] 2 times, [k2tog, k2] 2 times, (k1, yo, k1) all in next st, k1; rep from * to last st, k1.

Row 2: Purl.

Repeat Rows 1 and 2 once more. Cut yarn and change to B. Work garter st (knit every row) for 4 rows (2 garter ridges). BO all sts as for strip 1.

Finishing

Arrange strips side by side, alternating strip 1 and strip 2, and making sure that the strips are oriented so the colors alternate as well. With B threaded on tapestry needle, sew strips tog for about 1¼" (3.2 cm) where they touch in the middle and ¾" (2 cm) at their ends, leaving rem oval-shaped sections open.

Book Cover

Outer layer: With C, CO 64 sts. Work rev St st (purl on RS;

Hand painted *Morehouse* Merino Lace yarn inspired by
CLAUDE MONET

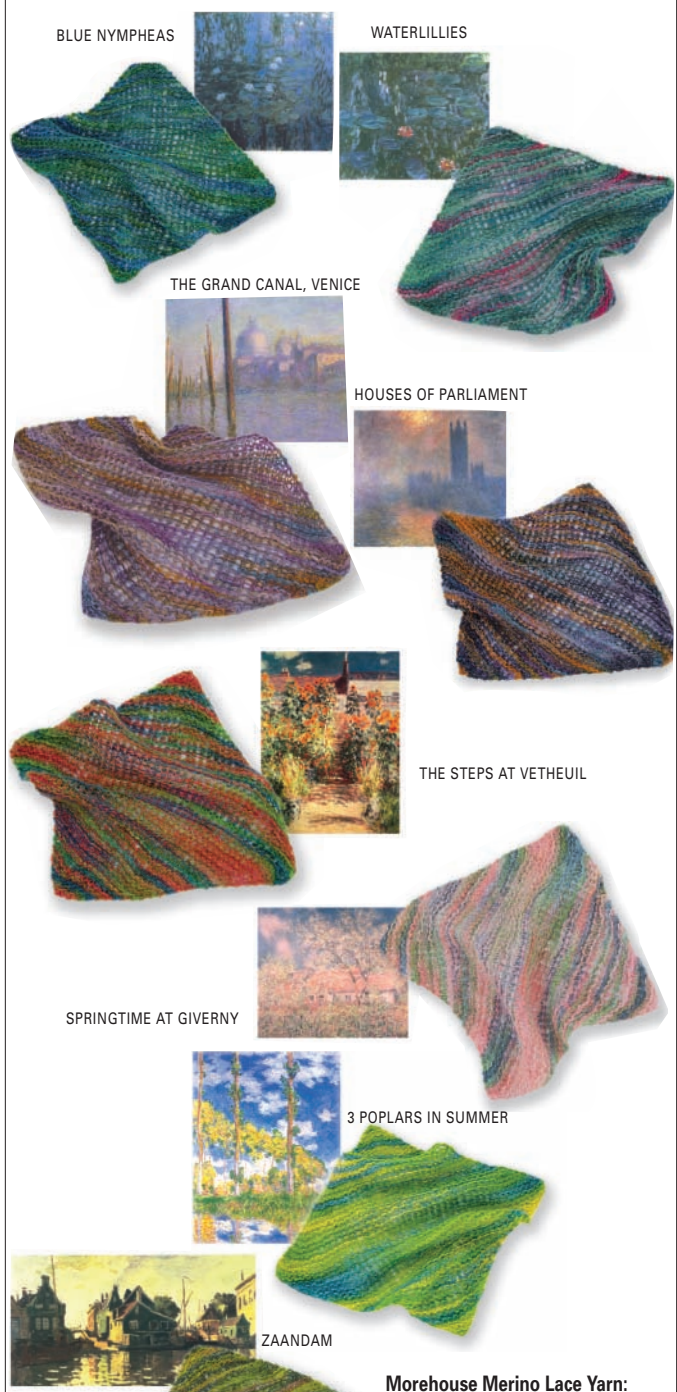

- Morehouse Merino Lace Yarn:**
- Single skein, 210 yards \$10
 - Double skein, 420 yards \$19
 - Triple skein, 630 yards \$28
 - Quad skein, 840 yards \$37
 - Cinque skein, 1050 yards \$46
 - Color Card with 8 samples \$5



Available toll-free 866-470-4852 or online at
www.MorehouseMerino.com

Or visit our shop Sheep's Clothing, 2 Rock City Road, Milan, NY 12571 (845)758-3710

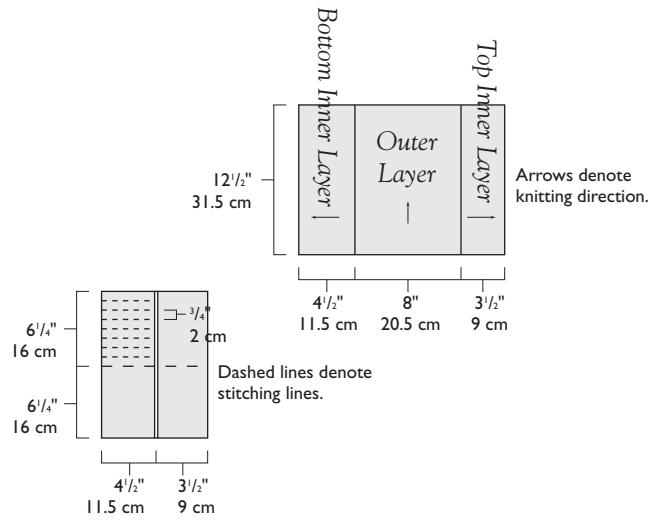

knit on WS) until piece measures 12½" (31.5 cm) from beg. BO all sts. **Inner layer top section:** Place assembled overlay on top of outer layer with RS of both outer layer and overlay facing you as shown (RS of outer layer is the purl side). Pin pieces together temporarily. With C and RS facing, pick up and knit 94 sts through both layers across one long edge. Knit 1 (WS) row, then purl 1 row. Work even in seed st until piece measures 3½" (9 cm) from pick-up row. BO all sts. **Inner layer bottom section:** Work as for inner layer top section until piece measures 4½" (11.5 cm). BO all sts. Remove any remaining pins.

Finishing

With C and crochet hook, work 2 rows of single crochet (see Glossary, page 106) through all layers along both short sides. If desired, cut two pieces of cardboard 6" x 3½" (15 x 9 cm). With C threaded on tapestry needle, sew a vertical seam down the center of the top inner layer. Insert cardboard stiffeners between the two layers on either side of the center seam, and sew across the bottom of each "pocket" to close. With C threaded on tapestry needle, sew a vertical seam down the center of the bottom inner layer to create two pockets. Sew 7 evenly spaced vertical seams about ¼" (2 cm) apart to divide the lower left pocket into 8 smaller pencil pockets. Weave in loose ends. **Twisted cord:** Cut one strand each of A, B, and C, each 78" (200 cm) long. Tie one end

of yarns in a knot and attach to a fixed object, such as a door-knob. Holding the strands taut, twist them clockwise until they kink upon themselves. Fold the strands in half and allow them to untwist against each other. Tie a knot at the opposite end. Trim ends. Slip the cardboard back of notebook into lower right inside pocket, and close cover like a book. Thread twisted cord through holes in overlay on outside of cover and tie closed. ∞

VÉRONIK AVERY keeps busy in Montreal, where she designs knitwear and is working on her first knitting book.

POLKA-DOT BAG

Kristin Nicholas

KRISTIN NICHOLAS'S CHEERFUL BAG will come in handy for carrying knitting, books, or even a few groceries. Stitches are picked up around a garter-stitch base and worked in the round from the bottom up, then the bag is felted in the washer to form a thick, sturdy fabric. For a splash of playful color, Kristin has added a smattering of embroidered circles. (For information on Kristin's new book, *Kids' Embroidery*, see Bookshelf, page 10.)

Finished Size 12" (30.5 cm) wide and 14" (35.5 cm) tall, after felting.

Yarn Devon Julia (50% wool, 25% kid mohair, 25% alpaca; 93 yd [85 m]/50 g): #6085 deep geranium (MC), 6 balls; small amount of #2163 golden honey, #2250 French pumpkin, #3961 lady's mantle, and #B118 espresso. Yarn distributed by Great Yarns of Raleigh, North Carolina.

Needles Size 10½ (6.5 mm): 24" (60-cm) circular (cir). Adjust needle size if necessary to obtain the correct gauge.



Joe Cooca

JAEGER

HANDKNITS

Classic Elegance... Contemporary Style



RONNIE FROM JB34, 12 DESIGNER GARMENTS & ACCESSORIES

FOR YOUR LOCAL STOCKIST CONTACT:

UK: JAEGER HANDKNITS TEL: 01484 680050 EMAIL: mail@knitrowan.com
 USA: JAEGER HANDKNITS TEL: (603) 886 5041 EMAIL: jaeger@westminsterfibers.com
 CANADA: DIAMOND YARN TEL: (416) 736 6111 EMAIL: diamond@diamondyarn.com
 AUSTRALIA: AUSTRALIAN COUNTRY SPINNERS TEL: 3 9380 3888
 EMAIL: sales@auspinner.com.au

a joy to knit,
a pleasure to wear



Holiday in Cashsoft 4ply, Classic Holiday



CLASSIC

UK: RYC t: 01484 681881 e: mail@ryclassic.com

USA: RYC USA t: (603) 886 5041
e: ryc@westminsterfibers.com

CANADA: Diamond Yarn t: (416) 736 6111
e: diamond@diamonyarn.com

AUSTRALIA: Australian Country Spinners t: 3 9380 3888
e: sales@auspinners.com.au

www.ryclassic.com

Notions Marker (m); tapestry needle.

Gauge 12 sts and 20 rows = 4" (10 cm) in St st worked in the rnd, before felting.

Bag

Base: With MC, CO 45 sts. Do not join into a rnd. Work garter st in rows (knit 1 row, purl 1 row) for 16 rows—8 garter ridges.

Sides: Cont with cir needle and using the yarn attached, pick up and knit 1 st in each valley between garter ridges (8 sts total) along selvedge edge of base, pick up and knit 1 st in each of 45 CO sts, then pick up and knit 1 st in each valley between garter ridges along rem selvedge edge—106 sts total. Place marker (pm) and join for working in the rnd. Work even in St st (knit every rnd) until piece measures 22" (56 cm) from pick-up rnd. **Upper edging:** *Purl 1 rnd, knit 1 rnd; rep from * once more. Purl 1 rnd. BO all sts.

Handles (make 2)

With MC, CO 6 sts. Work garter st in rows until piece measures 54" (137 cm) from beg. BO all sts.

Finishing

With yarn threaded on a tapestry needle, sew handles to top edge of bag if you will use a front-loading washing machine for felting; do *not* attach the handles if you will use a top-loading washing machine (to prevent handles from becoming entangled in the agitator). Sew handles to top of bag, about 3½" (9 cm) in from each side, leaving about 6" (15 cm) of handle dangling free below the stitching point. **Felting:** Put bag in washing machine (with handles in a separate pillowcase or lingerie bag if using a top-loader) and run through one cycle of hot water wash, cold water rinse. Repeat if necessary until bag has shrunk about 25% in width and 30% in length, or to about 12" (30.5 cm) wide and 14" (35.5 cm) tall. Blot with towels and let air dry. If you felted using a top-loader, sew handles to top edge of bag, about 2½" (6.5 cm) in from each edge, leaving about 4" (10 cm) of handle dangling free below the stitching point. **Embroidery:** With contrasting yarns threaded on a tapestry needle, work randomly placed spider web embroidery motifs (see box below) in assorted sizes and colors, including 1 small motif on top of the stitching point of each handle. Weave in loose ends. ∞

KRISTIN NICHOLAS is a knitwear designer, author, and decorative artist. Visit her website at www.kristinnicholas.com.

Spider Web Embroidery

Make a star-shaped foundation by working an odd number of straight stitches (five are shown here) that radiate out from the same point on the knitted fabric. Weave the threaded needle over and under the straight stitches in a circular motion to cover them.

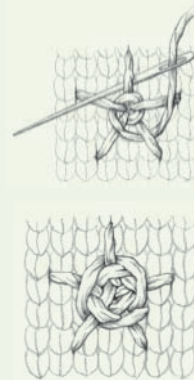



LACY KERCHIEF SCARF

Lisa Daehlin

LISA DAEHLIN COMBINES A traditional lace pattern with up-to-the-minute fashion in this pretty mercerized-cotton wrap. Worked sideways in a garter-stitch version of a leaf lace pattern, the project is easy to execute, even for a beginner. Wear it as a shawl, a scarf, or a hip wrap to show off your knitting style.

Finished Size 82¼" (210 cm) long and 12½" (31.5 cm) wide at center.

Yarn Garnstudio Muskat (100% Egyptian cotton; 109 yd [100 m]/50 g); #6 pink, 6 balls. Yarn distributed by Aurora Yarns.

Needles Size 6 (4 mm). Adjust needle size if necessary to obtain the correct gauge.

Notions A few yards (meters) waste yarn for provisional cast-on; markers (m); tapestry needle.

Gauge 20 sts and 28 rows = 4" (10 cm) in garter st; 5 repeats of 8-row leaf patt from chart (40 rows total) measure about 5¼" (14.5 cm) high.

Notes

The charted leaf pattern is deliberately not mirror-image symmetrical on both sides of the center "vein" of the leaves.

Take care that each stitch marker stays on the correct side of any adjacent yarnover, and does not migrate underneath the yarnover into the wrong position.

Scarf

Using a provisional method (see Glossary, page 105), CO 26 sts. Establish patt from Row 1 of Leaf chart as foll: (RS) Work until there are 8 sts on right needle, place marker (pm), work to end of row—28 sts after completing Row 1. Slipping marker every row, work Rows 2–8 of chart, then rep Rows 1–8 five more times—48 rows completed; 26 sts; piece should measure about 7" (18 cm) from beg. Establish garter st center section on next row as foll: (RS; Row 1 of chart) Work to 1 st before m, sl 1 st temporarily to right needle and remove m, return slipped st to left needle and knit in front and back of next st (k1f&b), replacing the marker between the 2 sts just worked into the same st, place a second m after inc'd st, work in patt to end—1 st inc'd; 8 sts before first marker; 1 st between markers; 20 sts after second marker. Working the sts on each side of the marked st in patt from chart as before, and working marked st in garter st every row, work Rows 2–8 of chart—27 sts; 8 sts before first m, 1 st between markers, 18 sts after second m. *Next row:* (Row 1 of chart) Work in patt to first m, sl m, k1f&b, sl m, work in patt to end—1 st inc'd; 2 garter sts between markers. Work Rows 2–8 of chart—28 sts; 8 sts before first m, 2 garter sts between markers,

elsebeth lavold



designer's choice

yarns you love for the craft you love

New yarn
Cable Cotton

New book
The Summer Breeze
Collection

And new colors in
Silky Wool, Silky Tweed and
Cotton Patiné

available at fine yarn shops nationwide

to view the entire line, please visit

www.knittingfever.com

or

www.ingenkonst.se

Email us at admin@knittingfever.com or
Call us at (516) 546-3600 for more information.



relax
play
holiday



Family
Hand Knitting Collection
Book number seven

JO SHARP

Jo Sharp's collection of comfortable hand knits for weekend wear.

Available at leading yarn stores.

Visit our website for stockists:

www.josharp.com.au

Exclusively distributed in USA by JCA Inc.
35 Scales Lane, Townsend MA 01469-1094
Ph: (978) 597 8794

18 sts after second m. *Next row:* (RS; Row 1 of chart) Work in patt to first m, sl m, k1f&b, knit to second m, sl m, work in patt to end. Work Rows 2–8 of chart. Rep the last 8 rows once more—30 sts; 8 sts before first m, 4 garter sts between markers; 18 sts after second m; 80 rows and 10 reps of chart completed; piece should measure about 11½" (29 cm) from beg. *Yarnover inc row:* (RS; Row 1 of chart) Work in patt to first m, sl m, knit to 2 sts before next m, yo, k2, sl m, work in patt to end—1 st inc'd between markers. Work 5 rows even in patt. Cont chart patt as established, rep the shaping of the last 6 rows 33 more times, then work yo inc row once more, ending with Row 5 of chart—39 garter sts between markers. Work through Row 8 of chart—65 sts; 8 sts before first m; 39 garter sts between markers; 18 sts after second m; 288 rows and 36 reps of chart completed; piece should measure about 41" (104 cm) from beg. *Dec row:* (RS; Row 1 of chart) Work in patt to first m, sl m, knit to 5 sts before second m, k2tog, yo, k2tog, k1, sl m, work in patt to end—1 st dec'd between markers. Work 5 rows even in patt. Cont charted patt as established, rep the shaping of the last 6 rows 33 more times, then work dec row once more, ending with Row 5 of chart—4 garter sts between markers. Work Rows 6–8 of chart—30 sts; 8 sts before first m; 4 garter sts between markers; 18 sts after second m; 496 rows and 62 reps of chart completed; piece should measure about 71" (180.5 cm) from beg. *Next row:* (RS; Row 1 of chart) Work in patt to first m, sl m, knit to 2 sts before next m, k2tog, sl m, work in patt to end—1 st dec'd between markers. Work Rows 2–8 of patt. Rep the last 8 rows 2 more times—27 sts; 8 sts before first m, 1 garter st between markers; 18 sts after second m. *Next row:* (RS; Row 1 of chart) Work in patt to 1 st before first m, temporarily sl 1 st to left needle and remove marker, return slipped st to left needle and k2tog (last st of first section with 1 rem garter st), sl m, work in patt to end—28 sts; 8 sts before m; 20 sts after m. Work Rows 2–8 of patt, then rep Rows 1–8 five more times—26 sts; 8 sts before m; 18 sts after m; 568 rows and 71 reps of chart completed; piece should measure about 81" (205.5 cm) from beg. Work end as foll:

Row 1: (RS) Removing m when you come to it, sl 1 pwise with yarn in back (wyb), k1, pass slipped st over (1 st on right needle), BO next 4 sts (1 st on right needle again), [k1, yo] 2 times, k1, ssk, p1, k2tog, k1, p1, k1, ssk, p1, k2tog, k1, yo, k3—20 sts.

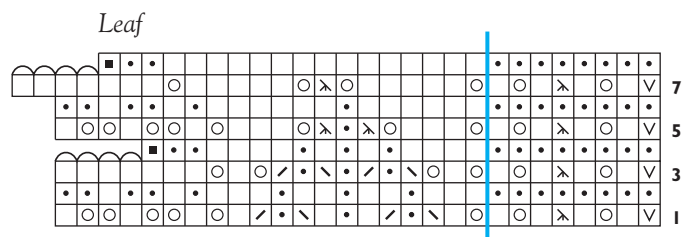

- k on RS; p on WS
- yo
- p on RS; k on WS
- sl 1, k2tog, pass slipped st over
- sl 1 pwise with yarn in back
- bind off 1 st
- k2tog
- marker position
- ssk
- st rem on needle after BO

Row 2: [K2, p1] 2 times, [k1, p2] 2 times, k1, p3, k1, sl 1 pwise with yarn in front (wyf), turn—2 sts rem unworked at end of this row.

Row 3: Sl 1 pwise wyb (same st as slipped at end of previous row), k2, yo, ssk, p1, k2tog, p1, ssk, p1, k2tog, yo, k1, yo, k2, turn—19 sts; 1 st unworked at end of this row.

Row 4: Sl 1 pwise wyf, k1, p4, [k1, p1] 2 times, k1, p4, k2, turn—1 st unworked at end of this row.

Row 5: Sl 1 pwise wyb, k2, yo, k2, yo, sl 1, k2tog, pss0, p1, sl 1, k2tog, pss0, yo, k3, yo, k2, turn—1 st unworked at end of this row.

Row 6: Sl 1 pwise wyf, k2, p6, k2, turn—7 sts unworked at end of this row.

Row 7: K10, turn—2 sts unworked at end of this row.

Row 8: [K1, yo] 16 times, k1; 35 sts total, including 2 unworked sts from Row 7.

Row 9: Knit across all sts.

Loosely BO all sts kwise.

Finishing

Remove waste yarn from provisional CO, place 26 live sts on needle, and join yarn with RS facing. Cont as foll:

Row 1: K3, [yo, k1] 18 times, turn—5 sts unworked at end of row.

Row 2: Knit all sts.

Row 3: Knit to last 2 sts, k2tog.

Slipping first st pwise wyb, loosely BO all sts kwise. Weave in loose ends. Block lightly. ∞

Lisa Daehlin lives in New York City. If she isn't knitting, she's likely to be singing opera.



TRIADA SCARF Jaya Srikrishnan

JAYA SRIKRISHNAN USES JUST ONE SKEIN of a delicate variegated mohair-blend yarn to make a scarf that can be worn in three ways—as a cowl, a neck warmer, or a scarf. The piece knits up quickly (in the round) on large needles in a simple rib pattern that produces an open, lacy feel with plenty of drape and stretch.

Finished Size
About 31"

(78.5 cm) long and 12" (30.5 cm) circumference when stretched lengthwise; 12" (30.5 cm) long and 34" (86.5 cm) circumference when stretched widthwise.

Yarn Fiesta Yarns La Boheme

A woman with long brown hair, wearing sunglasses and a white lace cardigan, is sitting on a beach. She is looking towards the camera. The background shows a beach with sand, rocks, and the ocean under a blue sky.

elann.com
Captivating Yarns . . .
Irresistible Prices

Register at www.elann.com to receive a free introductory copy of our newsletter with samples.

Pictured: Elann Cables and Lace Cardigan in 100% Cotton.



Knitting is always
in season at

STITCHES 2005

*Where knitters gather —
From across the country & around the world.*

Knitter's Getaway Maggie's Ireland

*May 31 - June 15, 2005
Belfast & More, Northern Ireland*

Camp Stitches NY

*July 7-11, 2005
Hamilton, New York*

Stitches Midwest

*August 11-14, 2005
Rosemont, Illinois*

Stitches East

*September 22-25, 2005
Atlantic City, New Jersey*

For details, a class brochure, or to sign up:

www.knittinguniverse.com
800.237.7099 or 605.338.2450

**XRX, Inc — Stitches Events,
Knitter's Magazine, and XRX Books**

(2-strand yarn: 64% brushed kid mohair, 28% rayon, 8% nylon; 165 yd [151 m]/4 oz): #11234 raspberry mocha, 1 skein.

Needles Size 17 (12.75 mm): 16" (40-cm) or 24" (60-cm) circular (cir).

Notions Size N/15 (10 mm) or larger crochet hook; a few yards (meters) of smooth waste yarn for provisional cast-on; marker (m); tapestry needle.

Gauge 5 sts and 13 rnds = 4" (10 cm) in fisherman's rib patt. Exact gauge is not important for this project.

Stitch Guide

Fisherman's Rib: (multiple of 2 sts)

Rnd 1: *K1, p1 into rnd below the st on the needle; rep from *.

Rnd 2: *K1 into rnd below the st on the needle, p1; rep from *.

Repeat Rnds 1 and 2 for pattern.

Notes

Wind the yarn into a ball by hand, taking care to match the colors on the mohair and the rayon strands. The rayon strand tends to stretch more than the mohair.

Line up the colors on both strands frequently when knitting. It is easier to take up the slack in the rayon in small sections rather than larger ones. Do not be concerned about small loops of the rayon bouclé—they will work themselves out as the scarf is stretched with use.

Scarf

With crochet hook and waste yarn, loosely chain (see Glossary, page 106) 40 sts. With knitting needle, working yarn, and beg with the 5th chain from the end, pick up and knit 1 st in the back of each of the next 31 chain sts—31 sts on needle. Join for working in the rnd, being careful not to twist sts. *Set-up rnd:* *K1, p1; rep from * to last st, place marker (pm) to indicate beg of rnd, sl 1, k1, pss0—30 sts rem; first st after marker counts as first st of fisherman's rib patt. Cont with p1, work Rnd 1 of fisherman's rib patt to end of rnd. Beg with Rnd 2, work Rnds 1 and 2 of fisherman's rib until about 75" (190 cm) of yarn remains, ending with Rnd 2—piece should measure about 24" (61 cm) from beg.

Finishing

Thread end of yarn on tapestry needle. While working bind-off, gently stretch apart the sts that are off the needle frequently to make sure that edge has enough width. To bind off, run yarn through all sts on needle as foll, leaving plenty of yarn between sts to ensure elasticity of edge. Each knit st will have an extra loop of thread between the st on the needle and the st below it—do not run the yarn through this loop. Catch only the st on the needle and the st below it with the tapestry needle. *Insert tapestry needle into knit st on needle and the st below it from front to back (i.e., from outside of circle to inside) and remove st from needle, pull yarn through gently, but do not pull tight—leave some slack; insert needle into purl st and the st below it from back to front (i.e., from inside of circle to outside) and remove st from needle, pull yarn through gently, but again, do not pull tight; rep from * to end. Remove marker. Insert needle into the first knit st again and weave in end to finish off. Remove waste yarn from provisional cast-on. Weave in rem loose ends. ∞

JAYA SRIKRISHNAN lives and knits in New York state.



**NEW
TITLES
FROM**

Montat
Publishing



Select project, gauge, & size and your pattern is created for you!



Finally! A universal sock pattern. Toe-up or cuff-down, 1 or 2 socks at once -- there's even an interchangeable heel & toe! Complete step by step illustrated instructions, and info on how to use this method with existing sock patterns. A must have for any sock knitter.



Unlimited possibilities! Pick a band, a style of hat, add some color or texture and you are on your way to a wonderful hat collection!

see these and more at
www.montat.com



Hemp Yarn

Knit this simple one-piece tank in the round using 24" circular size 2 & 4 needles. The neckline uses a decorative picot bind-off which requires no additional finishing. Finished chest: 33" (37, 42). Hemp Tank Kit: \$34.50 (44.00, 53.50). Please add \$7.25 shipping.



Request our free color catalog.

YARN BARN of Kansas

930 Massachusetts
Lawrence, KS 66044
www.yarnbarn-ks.com
1-800-468-0035

Goddess Yarns

Created for knitters by knitters

2911 Kavanaugh Blvd - Little Rock, AR 72205 - Toll Free (866) 332-YARN(8276)



O-Ring V-Neck
in Carmen

Entire collection available only at
www.goddessyarns.com

www.handworksgallery.com ~ www.needleworkunlimited.com
www.great-yarns.com ~ www.ruhamas.com

ACORN CAMISOLE

design by SHIRLEY PADEN

SHIRLEY PADEN BLENDS AN INTRICATE, TRADITIONAL LACE PATTERN with a contemporary silhouette for a garment that is both timeless and trend-conscious. The decreases and increases worked in the wavy stitch pattern form distinct scallops at the lower edge. The front is shaped into a modified bra top; the back is bound off straight across with a bit of elastic thread that helps to keep the camisole comfortably fitted.

Finished Size 28½ (34½, 40¼, 46½)" (72.5 [87.5, 102, 118] cm) chest/bust circumference. Camisole shown measures 34½" (87.5 cm).

Yarn Filatura di Crosa Millefili Fine (100% mercerized cotton; 136 yd [124 m]/50 g): #182 gray, 4 (4, 5, 5) balls.

Yarn distributed by Tahki/Stacy Charles.

Needles Size 7 (4.5 mm) and size 6 (4 mm). Adjust needle size if necessary to obtain the correct gauge.

Notions Tapestry needle; markers (m); stitch holders; safety pins; size E/4 (3.5 mm) crochet hook; 20 yd (20 m) gray or clear elastic thread for working upper edge of back.

Gauge 26 sts and 27 rows = 4" (10 cm) in St st on larger needles; 33 sts = 6" (15 cm) wide and 44 rows = 6¼" (17 cm) high in acorn patt on larger needles.

Stitch Guide

Single Decrease:

Right-side rows: Sl 1 knitwise (kwise) with yarn in back (wyb), k1, pass slipped st over (pss0)—1 st dec'd.

Wrong-side rows: P1, sl 1 kwise with yarn in front (wyf), return both sts to left needle, pass slipped st over purl st, return purl st to right needle—1 st dec'd.

Double Decrease:

Right-side rows: Sl 1 kwise wyb, k2tog, pss0—2 sts dec'd.

Wrong-side rows: P2tog, sl 1 kwise wyf, return both sts to left needle, pass slipped st over p2tog st, return p2tog st to right needle—2 sts dec'd.

Sloped Bind Off: On the row before binding off, do not work the last st of the row. Turn work—1 unworked st on right needle.

To bind off, sl first st on left needle to right needle pwise, and pass the unworked st over it to BO 1 st. Cont the rest of the bind off in the usual manner.

Picot Crochet Edging: Work *1 sl st in next st of garment edge, ch 4, skip 1 st from garment edge; rep from * to last st of garment edge, end with 1 sl st in last st.

Notes

The back and front contain an exact number of rows to the armhole, with no allowance for adjusting the length, in order to accommodate the planned decreases for the neckline.

Knit the first and last stitch of every row for selvedge stitches; these selvedge stitches are not shown on the chart.

Work waist and neckline decreases as follows: *Right-side rows:* Work first 3 sts as k1 (selvedge st), ssk; work last 3 sts as k2tog,

k1 (selvedge st). *Wrong-side rows:* Work first 3 sts as k1 (selvedge st), p2tog; work last 3 sts as ssp (see Glossary, page 105), k1 (selvedge st).

If there are not enough stitches as a result of shaping or sizing to work a yarnover or decrease with its companion decrease or yarnover, work the stitches in St st. If there is only one yarnover to compensate for a double decrease (instead of the required two yarnovers), convert the double decrease to a single decrease, and work both the yarnover and the single decrease; this is particularly important when shaping the fronts.

Back







With larger needles and using the knitted method (see Glossary, page 105), CO 85 (101, 117, 133) sts. Purl 1 WS row. On the next row (RS), work Row 1 of Acorn chart (see page 60), establishing selvedge sts and placing markers (pm) as foll: K1 (selvedge st, knit every row), pm, work 9 sts before patt rep box once, work 16-st patt rep 4 (5, 6, 7) times, work 10 sts after patt rep box once, pm, k1 (selvedge st, knit every row). Work 3 (3, 3, 4) more rows even in patt, ending with Row 4 (4, 4, 5) of chart. *Dec row:* Cont in patt from chart, dec 1 st each end of needle inside selvedge sts according to Notes—2 sts dec'd. Work 4 (4, 4, 0) rows even in patt, then rep dec row 1 (1, 1, 0) more time—81 (97, 113, 131) sts rem. Work 5 (5, 5, 6) rows even, then rep dec row—79 (95, 111, 129) sts rem. Rep the shaping of the last 6 (6, 6, 7) rows 3 more times, ending with Row 8 of chart—73 (89, 105, 123) sts rem; 34 patt rows completed; piece should measure about 5¼" (13.5 cm) from CO. Work even for 42 rows, ending with Row 24 of chart—76 patt rows completed; piece should measure about 11½" (29 cm) from CO. Change to smaller needles. Holding main yarn and elastic thread together, work Rows 25 and 26 of chart, then work Rows 1–4 once more—82 patt rows completed; piece should measure about 12½" (31.5 cm) from CO. With main yarn and elastic thread held tog, BO all sts.

Front

Work as for back until 34 patt rows have been completed, ending with Row 8 of chart—73 (89, 105, 123) sts; piece should measure about 5¼" (13.5 cm) from CO. Work even for 10 more rows, ending with Row 18 of chart—piece should measure about 6¼" (17 cm) from CO. *Inc row:* K1, M1 (see Glossary, page 105), work in patt to last st, M1, k1—2 sts inc'd. Work 3 rows even, then rep inc row—77 (93, 109, 127) sts. Rep the shaping of the last 4 rows 4 more times—85 (101, 117, 135) sts. Work 4 rows even,





 k on RS; p on WS	 single decrease (see Stitch Guide)	 yo
 p on RS; k on WS	 double decrease (see Stitch Guide)	 pattern repeat

Acorn

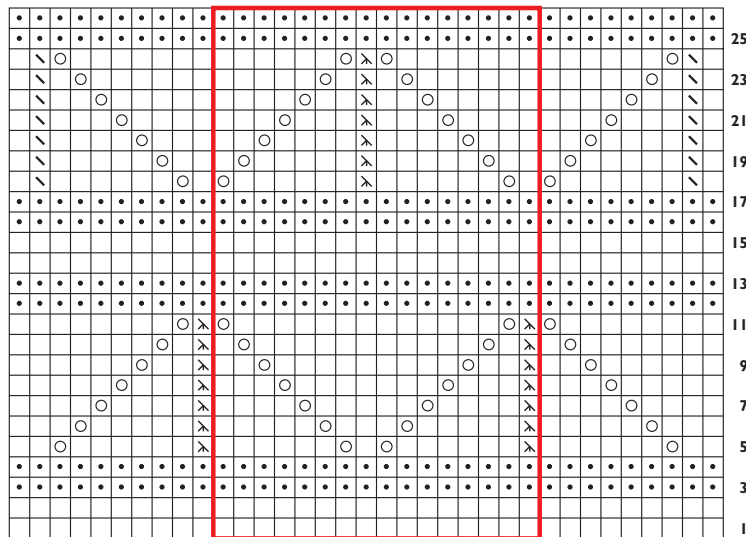

selvage sts not shown

then rep inc row—87 (103, 119, 137) sts. Work even in patt for 8 rows, ending with Row 26 of chart—78 patt rows completed; piece should measure about 12" (30.5 cm) from CO. **Shape armholes and neck:** (RS; Row 1 of chart) BO 5 (7, 9, 11) sts, work until there are 38 (44, 50, 57) sts on right needle, place all sts just worked onto a holder for left front, join second ball of yarn, BO 1 st (center st), work rem 43 (51, 59, 68) sts in patt for right front. **Right front:** Working right front sts only, BO 5 (7, 9, 11) sts at beg of next WS row—38 (44, 50, 57) sts. *Note:* The neck and armhole shaping are worked at the same time using the slope bind off technique (see Stitch Guide); please read the shaping section for your size all the way through before proceeding.

Size 28½": At neck edge (beg of RS rows), *BO 2 sts at beg of next RS row, then BO 1 st at beg of foll RS row; rep from * 4 more times, then BO 2 sts at beg of foll 3 RS rows, ending with Row 1 of chart. *At the same time,* at armhole edge (beg of WS rows), BO 1 st at beg of every WS row 12 times—5 sts rem when all shaping has been completed; 27 patt rows completed, including dividing row; piece should measure about 4¼" (11 cm) from dividing row.

Size 34½": At neck edge (beg of RS rows), BO 1 st at beg of next 15 RS rows, then BO 2 sts at beg of foll 3 RS rows, ending with a Row 11 of chart. *At the same time,* at armhole edge (beg of WS rows), BO 2 sts at the beg of first WS row, then BO 1 st at beg of every WS row 16 times—5 sts rem when all shaping has been completed; 37 patt rows completed, including dividing row; piece should measure about 5¾" (14.5 cm) from dividing row.

Size 40¼": At neck edge (beg of RS rows), *BO 1 st at beg of next RS row, then BO 2 sts at beg of foll RS row; rep from * 6 more times, then BO 2 sts at beg of foll 4 RS rows, ending with Row 11 of chart. *At the same time,* at armhole edge (beg of WS rows), do not BO at the beg of the first WS row. Beg with the foll WS row, BO 1 st at the beg of every WS row 16 times—5 sts rem when all shaping has been completed; 37 patt rows completed, including dividing row; piece should measure about 5¾" (14.5 cm) from dividing row.

Size 46½": At neck edge (beg of RS rows), BO 1 st at beg of first 4 RS rows, then *BO 2 sts at beg of next RS row, then BO 1 st at beg of foll RS row; rep from * 3 more times, then BO 2 sts at beg of foll 6 RS rows, ending with Row 11 of

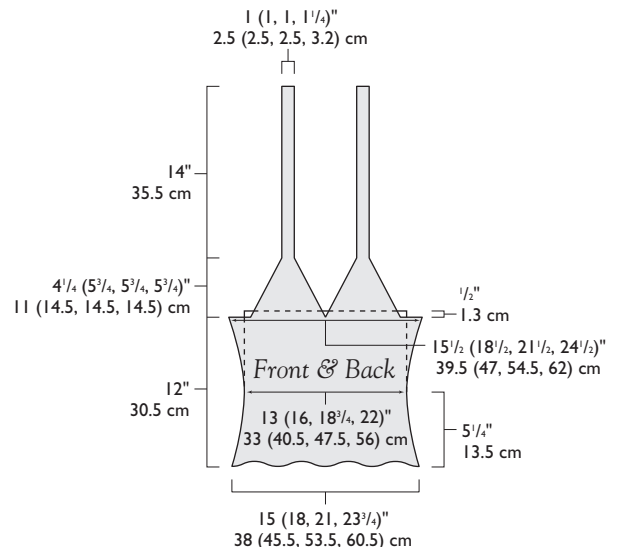



the yarn lounge
 classes, accessories, and cool natural fibers

3003 west cary street
 Richmond, Virginia 23221
 tel 804 340 2880

theyarnlounge.com

T/W 10-6 TH 10-7 F/S 10-6 SU 12-5
 closed Monday

it's hip to knit

14 inch tall bear • 1 pattern • 3 yarn choices • find your retailer at blueskyalpacos.com



Baby Bobbi Bear
 Another bear essential from
 Blue Sky Alpacos

Julia
 Signature yarn from renowned designer
 Kristin Nicholas



An amazing blend of kid mohair, alpaca and wool. Available in 25 beautiful shades. Perfect for keepsake sweaters and inspired multicolored knitting. Color card available at www.great-yarns.com

Field of Diamonds Pillow Kit
 \$79.95 + shipping

To order, call 1-800-810-0045

Great Yarns, Inc. 1208 Ridge Road,
 Ridgewood Shopping Center, Raleigh, NC 27607

For more Kristin Nicholas artwork and designs, visit
www.kristinnicholas.com



Colour & Style captivates the Imagination
 Another Dimension in Handpainted yarns

"Jazz"

**KOIGU
 WOOL
 DESIGNS**

1-888-765-WOOL www.koigu.com

Vittadini Jo Sharp Debbie Bliss Blue Sky Alpaca Filatura di Crosa

Prism Berroco Noro Lana Grossa Mission Falls Rowan Integer

Jamieson's Trendsetter Manos Colnette Alchemy Geddfra

COLORFUL STITCHES

www.colorful-stitches.com 800-413-6111

Koigu Stacy Charles Hanne Falkenberg Classic Elite Karabella

chart. At the same time, at armhole edge (beg of WS rows), BO 1 st at the beg of every WS row 12 times, then BO 2 sts at beg of next 5 WS rows—7 sts rem when all shaping has been completed; 37 patt rows completed, including dividing row; piece should measure about 5¼" (14.5 cm) from dividing row.

Straps: For all sizes, knit the first and last st of every row, and work center 3 (3, 3, 5) sts in St st until strap measures 14" (35.5 cm). Place sts on holder. **Left front:** Return 38 (44, 50, 57) held sts for left front to needle and rejoin yarn ready to work a WS row. Work 1 WS row (Row 2 of chart) even. Reverse shaping and complete as for right front by working armhole BO at beg of RS rows, and working neck BO at beg of WS rows—5 (5, 5, 7) sts rem when all shaping has been completed. Work strap for 14" (35.5 cm) as for right front. Place sts on holder.

Finishing

Block piece to measurements. With yarn threaded on a tapestry needle, sew side seams, matching rev St st rows. Temporarily pin ends of straps to top edge of back, positioning each strap ¾ (4½, 4½, 6)" (8.5 [11.5, 11.5, 15] cm) in from side seam. Try on camisole and adjust strap length, adding or subtracting rows as required for proper fit. BO straps sts, but do not attach them to back yet. Join yarn to top of left side seam with RS facing, and using crochet hook (see Glossary, page 106, for crochet instructions), work 1 row of picot crochet (see Stitch Guide) across sts BO for left front armhole, up the armhole side of left front, and along the armhole side of left strap. Work slip st across BO edge of left strap. Resume working picot crochet along the neck side of left strap, down the left front neck to center front, up the right front neck, and along the neck side of right strap. Work slip st across BO edge of right strap. Resume working picot crochet along armhole side of right strap, down armhole side of right front, and across BO sts at right armhole. Sew straps to back, aligned with the center of each front, about ¾ (4½, 4½, 6)" (8.5 [11.5, 11.5, 15] cm) in from side seams. Weave in loose ends. ∞

SHIRLEY PADEN designs knitwear for magazines, yarn companies, and private clients from her home in New York City.

CASCADE YARNS
DISTRIBUTOR OF FINE YARN

cascadeyarns.com

CASCADE SIERRA YARN
20% WOOL 80% PIMA COTTON • AVAILABLE IN 80 COLORS

DID YOU KNOW that Cascade Sierra yarn is a blend of Pima Cotton and Merino wool from the highlands of Peru? It has the breathability of wool plus wonderful color pallet achievable only with pima cotton. It is the perfect year round fiber combination. Become a fiber artist with our color pallet of over 80 colors. This is pure proof that you can improve on Mother Nature. **Look at all the Cascade Yarns online including Di.Ve', Bollicine.** Ask at your local yarn shop for Sierra from Cascade or contact us at sales@cascadeyarns.com for your nearest stockist.

#105 Glenwood

LORNA'S
Laces
HAND-DYED YARNS

773.935.3803 yarn@lornaslaces.net www.lornaslaces.net
Please visit us online for a retail location near you.

SWTC
South West Trading Company

Mariposa
designed by Merrily Parker

KNIT WITH SWTC BAMBOO YARN

South West Trading Company yarns and patterns are available at fine yarn stores. Visit www.soysilk.com for retail listings.

Yarn SALE
PRESENTED BY *Herrschners*

SAVE up to **60% off** RETAIL!

FREE Moda Dea pattern!
www.YarnSale.com/InterweaveKnits

YarnSale.com New sale each week!

GOURMET YARNS,
STYLISH PATTERNS

REQUEST YOUR FREE CATALOG TODAY.

1-800-441-0838 MENTION "INTERWEAVE KNITS"
WWW.YARNSHOPPE.COM/INTERWEAVEKNITS

knitting central
where creativity comes in endless colors

582 Post Road East, Westport CT 06880 203.454.4300
www.knittingcentral.com

FIERY BOLERO

design by DEBBIE BLISS

HER LOVE OF FLAMENCO MUSIC INSPIRED DEBBIE BLISS to create a short, fitted bolero that's reminiscent of the cropped jackets worn by Spanish dancers. With proportions that work well over a sleek sleeveless dress or body-hugging camisole, the bolero is knitted in a single piece: Cast on at the lower back edge, work up to the shoulder, then work each front separately from the neck down. A simple ribbed border provides a tidy edging.

Finished Size 31¼ (32¾, 35, 36½, 38)" (79.5 [83, 89, 92.5, 96.5] cm) chest/bust circumference. Sweater shown measures 35" (89 cm).

Yarn Debbie Bliss Cathay (50% cotton, 35% viscose, 15% silk; 110 yd [100 m]/50 g): #03 red, 5 (5, 6, 6, 7) balls. Yarn distributed by Knitting Fever.

Needles Body and sleeves—Size 5 (3.75 mm): straight and 24" (60-cm) circular (cir). Edging—Size 3 (3.25 mm): 24" (60-cm) cir. Adjust needle size if necessary to obtain the correct gauge.

Notions Removable markers; stitch holders; tapestry needle.

Gauge 22 sts and 30 rows = 4" (10 cm) in St st on larger needles.

Notes

The body is worked in one piece beginning at the curved lower back edge, up and over the shoulders with stitches cast on for sleeves, and then divided into two fronts that are worked separately to the shaped lower front edges.

The short-rows used to shape the shawl collar are simply turned, without wrapping any of the turning stitches, to leave a small, decorative eyelet at each turning point.

Body

With larger straight needles, CO 16 (20, 18, 22, 16) sts. Purl 1 (WS) row. Beg with a RS row, work in St st, and *at the same time* use the cable method (see Glossary, page 104) to CO 9 (9, 10, 10, 11) sts at beg of next 8 rows—88 (92, 98, 102, 104) sts. Work 20 (22, 24, 26, 30) rows even—piece should measure about 4 (4¼, 4½, 4¾, 5¼)" (10 [11, 11.5, 12, 13.5] cm) from CO (measured straight up from center of lower edge) and about 2¾ (3, 3¼, 3½, 4)" (7 [7.5, 8.5, 9, 10] cm) from last CO row (measured along straight section of selvedge). Change to larger cir needle. **Cast on for sleeves:** Use the cable method to CO 4 (5, 6, 7, 8) sts at beg of next 12 rows—136 (152, 170,

186, 200) sts. Work 36 (40, 42, 46, 48) rows even, ending with a WS row—piece should measure about 4¾ (5¼, 5½, 6¼, 6½)" (12 [13.5, 14, 16, 16.5] cm) from last sleeve CO row. Place removable marker at each end of last row to mark shoulder line. **Divide for fronts:** (RS) K56 (63, 71, 78, 84) sts for right front, BO next 24 (26, 28, 30, 32) sts, knit to end—56 (63, 71, 78, 84) sts at each side. **Left front:** Work 11 (9, 9, 7, 7) rows even on 56 (63, 71, 78, 84) left front sts *only*, ending with a WS row. **Inc row:** (RS) K3, M1 (see Glossary, page 105), knit to end—1 st inc'd at neck edge (beg of RS rows). Work 3 rows even. Rep the last 4 rows 5 (6, 7, 8, 9) more times, then work inc row once more—63 (71, 80, 88, 95) sts. Place removable marker at beg of last row to indicate end of neck shaping. Work 4 (4, 2, 2, 2) rows even, ending with a RS row—piece should measure about 10¼ (11, 11½, 12½, 13¼)" (26 [28, 29, 31.5, 33.5] cm) from last sleeve CO row. **Bind off for sleeve:** Beg with next WS row, BO 4 (5, 6, 7, 8) sts at beg of every WS row (cuff edge) 6 times—39 (41, 44, 46, 47) sts rem. Work 4 (4, 0, 0, 2) rows even, ending with a WS row. Place removable marker at end of last row to indicate beg of lower front shaping. **Shape lower front:** (RS) K1, sl 1, k1, pss0, knit to end—1 st dec'd. Purl 1 (WS) row. Rep the last 2 rows 1 (2, 5, 6, 7) more time(s)—37 (38, 38, 39, 39) sts rem. Beg with the next RS row, at center front edge (beg of RS rows), BO 2 sts once, then BO 3 sts once, then BO 4 sts once, then BO 5 sts once, then BO 6 sts once, then BO 7 (7, 7, 8, 8) sts once—10 (11, 11, 11, 11) sts rem; piece should measure about 2¾ (3, 3¼, 3½, 4)" (7 [7.5, 8.5, 9, 10] cm) from last sleeve BO row. Purl 1 (WS) row. Place sts on holder. **Right front:** With WS facing, join yarn to 56 (63, 71, 78, 84) right front sts, purl to end. Work 10 (8, 8, 6, 6) rows even, ending with a WS row. **Inc row:** (RS) Knit to last 3 sts, M1, knit to end—1 st inc'd at neck edge (end of RS rows). Work 3 rows even. Rep the last 4 rows 5 (6, 7, 8, 9) more times, then work inc row once more—63 (71, 80, 88, 95) sts. Place removable marker at end of last row to indicate end of neck shaping. Work 5 (5, 3, 3, 3) rows even in St st, ending with a WS row—piece should measure about 10¼ (11, 11½, 12½, 13¼)" (26 [28, 29, 31.5, 33.5] cm) from last sleeve CO row. **Bind off for sleeve:** Beg with the next RS row, BO 4 (5, 6, 7, 8) sts at beg of every RS row (cuff edge) 6 times—39 (41, 44, 46, 47) sts rem. Work 5 (5, 1, 1, 3) row(s) even, ending with a WS row. Place removable marker at beg of last row to indicate beg of lower front shaping. **Shape lower front:** (RS) Knit to last

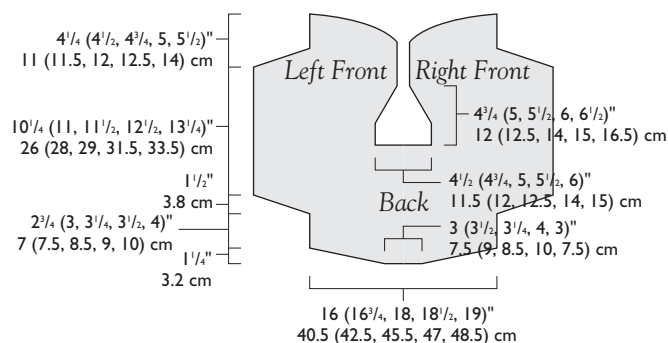





3 sts, k2tog, k1—1 st dec'd. Purl 1 (WS) row. Rep the last 2 rows 1 (2, 5, 6, 7) more time(s)—37 (38, 38, 39, 39) sts rem. Knit 1 (RS) row. Beg with the next WS row, at center front edge (beg of WS rows) BO 2 sts once, then BO 3 sts once, then BO 4 sts once, then BO 5 sts once, then BO 6 sts once, then BO 7 (7, 7, 8, 8) sts once—10 (11, 11, 11, 11) sts rem; piece measures same as left front from last sleeve BO row. Place sts on holder.

Finishing

Front edging and collar: With smaller cir needle, RS facing, and beg at side edge of lower right front edge, k10 (11, 11, 11, 11) held right front sts, pick up and knit 40 (42, 44, 46, 48) sts evenly spaced along shaped lower edge of right front to marker, 20 (20, 21, 22, 23) sts along straight selvedge between markers, 41 (43, 45, 47, 49) sts from marker to sts BO for neck, 24 (26, 28, 30, 32) sts along back neck, 41 (43, 45, 47, 49) sts to marker for end of neck shaping, 20 (20, 21, 22, 23) sts along straight selvedge between markers, and 40 (42, 44, 46, 48) sts evenly spaced along shaped lower edge of left front, then k10 (11, 11, 11, 11) held left front sts—246 (258, 270, 282, 294) sts total. *Next row:* P2, *k2, p2; rep from *. Cont in short-rows as foll:

Short-rows 1 and 2: Work in established rib until 107 (112, 117, 122, 127) sts remain unworked, turn.

Short-rows 3 and 4: Work in rib until 102 (107, 112, 117, 121) sts rem unworked (5 [5, 5, 5, 6] sts past previous turning point), turn.

Short-rows 5 and 6: Work in rib until 97 (102, 107, 111, 115) sts rem unworked (5 [5, 5, 5, 6] sts past previous turning point), turn.

Short-rows 7 and 8: Work in rib until 93 (97, 102, 105, 109) sts rem unworked (4 [5, 5, 5, 6] sts past previous turning point), turn.

Short-rows 9 and 10: Work in rib until 89 (92, 97, 100, 104) sts rem unworked (4 [5, 5, 5, 5] sts past previous turning point), turn.

Short-rows 11 and 12: Work in rib until 85 (88, 92, 95, 99) sts rem unworked (4 [4, 5, 5, 5] sts past previous turning point), turn.

Short-rows 13 and 14: Work in rib until 81 (84, 87, 90, 94) sts rem unworked (4 [4, 5, 5, 5] sts past previous turning point), turn.

Next row: Work in rib across all sts to end. Work 7 more rows in rib. BO all sts in rib.

Lower back edging: With smaller cir needle and RS facing, pick up and knit 90 (94, 98, 102, 106) sts along lower back edge. Cont as foll:

Row 1: (WS) P2, *k2, p2; rep from *.

Row 2: K2, *p2, k2; rep from *.

Rep these 2 rows 3 more times, then work Row 1 once more. BO all sts in rib. **Cuffs:** With smaller cir needle and RS facing, pick up and knit 54 (62, 66, 74, 78) sts across lower sleeve edge. Work ribbing as for lower back edging. With yarn threaded on a tapestry needle, sew side and sleeve seams. Weave in loose ends. Block lightly to measurements. ∞

DEBBIE BLISS lives in the United Kingdom where she designs knitwear, writes knitting books, and markets her own line of knitting yarns.

Denise Interchangeable Knitting Needles \$44.95

Felted Satchel Kit \$39.95

Lighthouse Bag with Stand \$91.95

Felted Knits Book \$21.95

These are a few of our favorite things...
HALCYON YARN
 1-800-341-0282 / halcyonyarn.com

FELTED KNITS

Beverly Galaskas



Rose Trellis Cardigan - Pattern Available

New England Shetland Yarns

Luxurious Yarns from 100% Virgin Wool

Call for Samples & Information: 1-800-338-9415
or visit our website: www.harrisville.com

Fine yarns spun by:

HD HARRISVILLE DESIGNS, INC.
Center Village, Harrisville, New Hampshire 03450



Trendsetter, Prism,
Muench, Berroco,
Anny Blatt, Cascade,
Plymouth, Skacel,
Rowan, Euro,
Tahki/Stacy Charles
and more available
ONLINE at

www.yarnlady.com

or drop on by the
shop!

24371 Avenida
De La Carlota #M
Laguna Hills, Ca
92653

(949) 770-7809 or toll
free ORDER line:
(888) 770-7809



VALLEY  **YARNS™**

Discover the beauty
of Valley Yarns —
an exciting collection
of yarns that are
fun to knit and
easy to wear.

presented by



Created by people who love yarn

75 SERVICE CENTER RD., NORTHAMPTON, MA 1.800.367.9327 WWW.YARN.COM

BRITTANY
brittanyneedles.com



made in
Northern California
of sustainably
harvested
domestic birch
hardwood



PREMIERE PULLOVER

design by FIONA ELLIS

FIONA ELLIS ADMITS THAT SHE FINDS IT A CHALLENGE to design summer knitwear. She likes a sweater that will ward off the occasional chill, but she doesn't want to feel bundled up. A lightweight cotton/tencel blend makes this cabled pullover a summertime classic. An unusual lace pattern forms a deep border for the body and sleeves, and it's repeated, with a slight picot edging, in the high collar. Slit cuffs give the sleeves a graceful bell shape.

Finished Size 32 (37, 42½, 48, 53)" (81.5 [94, 108, 122, 134.5] cm) chest/bust circumference. Sweater shown measures 37" (94 cm).

Yarn Classic Elite Premiere (50% cotton, 50% tencel; 108 yd [99 m]/50 g): #5248 pond (light blue), 11 (12, 13, 15, 17) skeins.

Needles Size 5 (3.75 mm). Adjust needle size if necessary to obtain the correct gauge.

Notions Cable needle (cn); stitch holders; tapestry needle; size E/4 (3.5 mm) crochet hook.

Gauge 24½ sts and 30 rows = 4" (10 cm) in cable patt from chart.

Back

CO 92 (107, 122, 137, 152) sts. Knit 1 (RS) row. Work set-up row (WS) of Lace chart (see page 70) once (do not rep set-up row). Rep Rows 1–4 of Lace chart 5 times, then work Row 1 once more—22 rows total, including set-up row; piece should measure about 3" (7.5 cm) from beg. *Inc row:* (WS) P5, *k2, p1, purl in front and back of next st (p1f&b), p1, k2, p8; rep from * to last 12 sts, k2, p1, p1f&b, p1, k2, p5—98 (114, 130, 146, 162) sts. Rep Rows 1–4 of Cable chart until piece measures 13½ (13½, 14, 14½, 15½)" (34.5 [34.5, 35.5, 37, 39.5] cm) from beg, ending with a WS row. **Shape armholes:** Cont in patt, BO 3 sts at beg of next 4 rows—86 (102, 118, 134, 150) sts rem. Dec 1 st each end of needle every row 5 times—76 (92, 108, 124, 140) sts rem. Work even in patt until armholes measure 7½ (7½, 8, 8½, 9)" (19 [19, 20.5, 21.5, 23] cm), ending with a WS row. **Shape shoulders:** Cont in patt, BO 5 (8, 10, 12, 14) sts at beg of next 6 rows—46 (44, 48, 52, 56) sts rem (second size deliberately has fewer sts than smallest size). Place sts on holder.

Front

CO and work as for back until armholes measure 5 (5, 5½, 6, 6)" (12.5 [12.5, 14, 15, 15] cm), ending with a WS row—76 (92, 108, 124, 140) sts. **Shape neck:** (RS) Cont in patt, work across 30 (36, 42, 48, 54) sts, place rem 46 (56, 66, 76, 86) sts on spare needle or holder, turn work. **Left front:** Working 30 (36, 42, 48, 54) left front sts, cont in patt as foll: At neck edge, dec 1 st every row 15 (12, 12, 12, 12) times—15 (24, 30, 36, 42) sts rem. Work even in patt until armhole measures 7½ (7½, 8, 8½, 9)" (19 [19, 20.5, 21.5, 23] cm), ending with a WS row. Cont in patt, at armhole edge (beg of RS rows) BO 5 (8, 10, 12, 14) sts 3 times. **Right front:** With RS facing, place 16 (20, 24, 28, 32) held sts at center front onto separate holder, return rem 30 (36, 42, 48, 54) sts to needle for right front, and rejoin yarn with RS facing. Cont in patt, dec 1 st at neck edge every row 15 (12, 12, 12, 12) times—15 (24, 30, 36, 42) sts rem. Work even in patt until armhole measures the same as left front to shoulder shaping, ending with a RS row. Cont in patt, at armhole edge (beg of WS rows) BO 5 (8, 10, 12, 14) sts 3 times.

Sleeves

CO 62 sts. Knit 1 (RS) row. Work set-up row (WS) of Lace chart once (do not rep set-up row). Rep Rows 1–4 of Lace chart 7 times, then work Row 1 once more—30 chart rows total, including set-up row; piece should measure about 4" (10 cm) from beg. *Inc row:* (WS) P5, *k2, p1, p1f&b, p1, k2, p8; rep from * to last 12 sts, k2, p1, p1f&b, p1, k2, p5—66 sts. Rep Rows 1–4 of Cable chart and *at the same time*, working new sts into patt as they become avail-

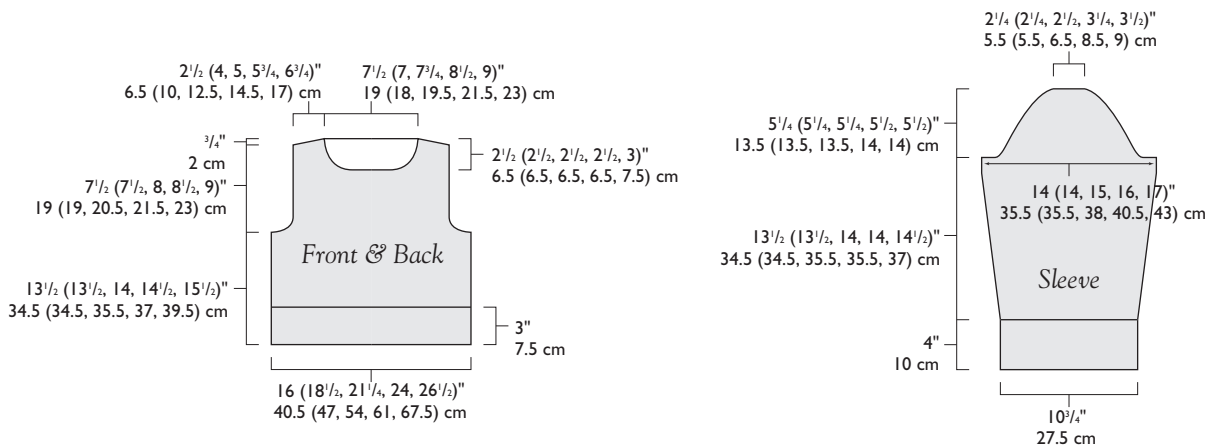

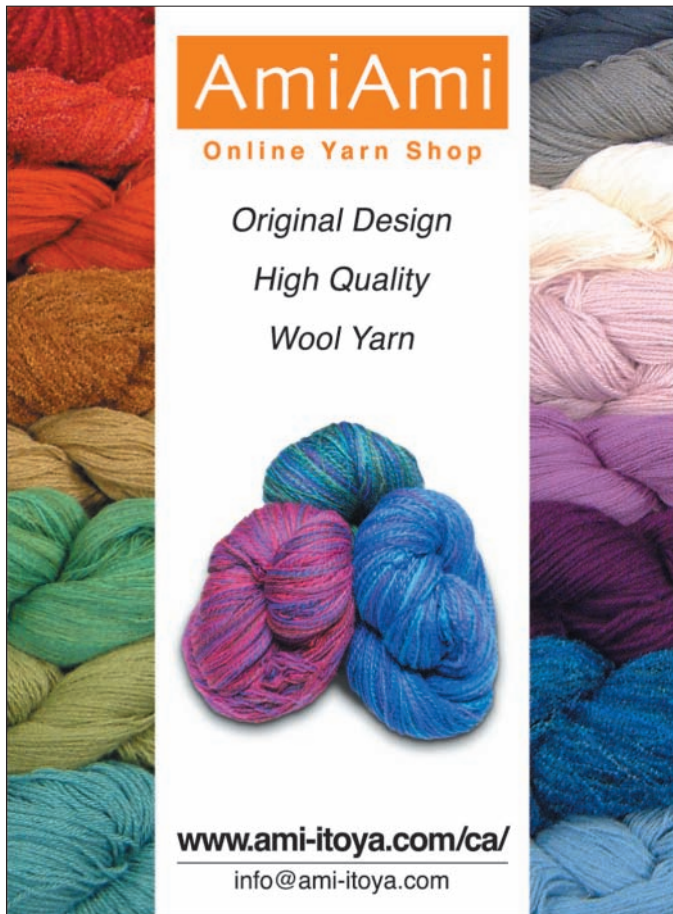

AmiAmi
Online Yarn Shop

Original Design
High Quality
Wool Yarn

www.ami-itoya.com/ca/
info@ami-itoya.com



COTONĀDE 

- 100% cotton
- 24 fun colors
- 4 sts per inch

Visit us online to find a retailer in your area at
www.knitonecrochettoo.com
or call us at 207-892-9625





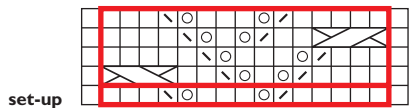

wholesale inquiries only
800-357-7646

Cable

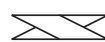

Lace



- | | | | |
|---|--|---|---|
|  | k on RS; p on WS |  | 2/2RC: sl 2 sts onto cn and hold in back, k2, k2 from cn |
|  | p on RS; k on WS |  | 2/2LC: sl 2 sts onto cn and hold in front, k2, k2 from cn |
|  | k2tog on RS; p2tog on WS |  | pattern repeat |
|  | ssk on RS; ssp on WS
(see Glossary) | | |
|  | yo | | |

able, inc 1 st each end of needle on the 7 (7, 5, 5, 5)th row, then every foll 8 (8, 8, 6, 6)th row 5 (5, 7, 15, 11) times—78 (78, 82, 98, 90) sts. Inc 1 st each end of needle every 10 (10, 6, 0, 4)th row 4 (4, 5, 0, 7) times—86 (86, 92, 98, 104) sts. Work even in patt until piece measures 17½ (17½, 18, 18, 18½)" (44.5 [44.5, 45.5, 45.5, 47] cm) from beg, ending with a WS row. **Shape cap:** Cont in patt, BO 3 sts at beg of next 4 rows—74 (74, 80, 86, 92) sts rem. Dec 1 st each end of needle every RS row 13 (13, 13, 14, 14) times—48 (48, 54, 58, 64) sts rem. Dec 1 st each end of needle every row 5 times—38 (38, 44, 48, 54) sts rem. BO 6 (6, 7, 7, 8) sts at beg of next 4 rows—14 (14, 16, 20, 22) sts rem. BO all sts.

Finishing

Weave in loose ends. Block pieces to measurements. With yarn threaded on a tapestry needle, sew right shoulder seam. With RS facing and beg at left shoulder, pick up and knit 22 (22, 25, 21, 25) sts along left front neck, knit across 16 (20, 24, 28, 32) held front neck sts, pick up and knit 23 (21, 25, 21, 24) sts along right front neck, then knit across 46 (44, 48, 52, 56) held back neck sts—107 (107, 122, 122, 137) sts total. Work set-up row (WS) of Lace chart (do not rep set-up row). Rep Rows 1–4 of Lace chart 5 times, then work Row 1 once more—22 chart rows total; neck should measure about 3" (7.5 cm) from pick-up row. **Picot BO:** BO 3 sts, *slip rem st on right needle back onto left needle and use the backward loop method (see Glossary, page 104) to CO 3 sts, BO 5 sts; rep from * to end. Sew left shoulder and neck seam. Sew sleeves into armholes. Sew sleeve and side seams, leaving lower 4" (10 cm) of sleeves (lace portion) open. With crochet hook, RS facing, and beg at CO edge, work 1 row of single crochet (see Glossary, page 106) up each sleeve slit to beg of seam, then down the other side of slit to CO edge. ∞

FIONA ELLIS lives in Toronto where she's working on a book about cable knitting for Clarkson Potter (scheduled publication date of 2006).

Denise

INTERCHANGEABLE™
Knitting Needles



Relax.
We're all here.

- Sizes 5-15 (U.S.)
- 10 pairs circular & straight
- variable lengths
- stitch holders included
- compact 7" x 8.5" case
- airline safe

New Cords Available!
40" and 52" (sold separately)

Unique Connection

Insert cord
into needle



Twist 1/4 turn
to lock



visit your knit shop

www.knitdenise.com
888-831-8042 toll free

1618 Miller School Road
Charlottesville, VA 22903



**Simply... Sophisticated,
Inspiring, Color.**

Our premium fibers are hand-dyed.
Choose from 14 unique lines in up to 38 colorways.

Visit our new website to find a retailer in your area.
www.FiestaYarns.com

For wholesale inquiries please call 505.892.5008

©2004 Fiesta Yarns Albuquerque, NM

THE PRIMERA COLLECTION

...FOR PEOPLE WHO CAN HAVE
WHATEVER THEY WANT

A FINE COLLECTION OF CASHMERES,
SILKS, DENIMS, EXOTIC RABBIT,
FOX, ANGORAS, AND MORE

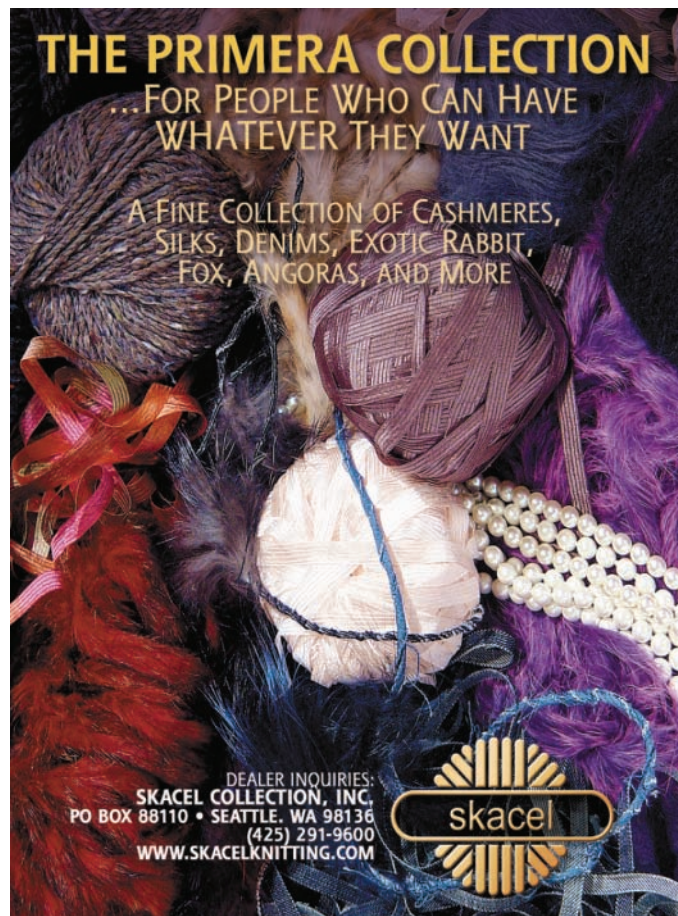

DEALER INQUIRIES:
SKACEL COLLECTION, INC.
PO BOX 88110 • SEATTLE, WA 98136
(425) 291-9600
WWW.SKACELKNITTING.COM

skacel

WHITE LIES DESIGNS

ROMANTIC
STYLES FOR
KNITTERS

BY JOAN
MCGOWAN-MICHAEL



Style #139

Amelie

The marriage of knit & crochet is celebrated beautifully in this shapely little jacket. Bracelet length sleeves, a deep V-neck & a curved peplum are proof that even though married, flirting is still allowed.

Yarnpack contains 100% Cotton yarn in Teal Blue/Lilac (shown), Ivory/Taupe.

- Sizes 32-48"
- Yarnpack: \$42-\$48-\$54 (US shipping \$9)
- Pattern: \$10.25 (includes US shipping)

PATTERNS AND KITS IN SIZES 34-60"

PO Box 214883, Sacramento, CA 95821, (916)247-5580
Online brochure at www.whiteliesdesigns.com

BUFFALO GIRL

design by THERESE CHYNOWETH

SOFT, WARM BUFFALO YARN in its natural color, a deep, rich brown, knits up in a neck warmer and wristlets that rival the softest merino for comfort. The pieces are worked in the round in an unfussy, reversible lace pattern and finished off with a simple crochet edging. When you make these warmers as gifts—or for yourself—don't forget to give a nod to Annie Oakley, the original Buffalo Girl.

Finished Size Neck warmer: 15 (17)" (38 [43] cm) neck circumference with fabric relaxed; will stretch to fit over a 19½ (24)" (49.5 [61] cm) head. Neck warmer shown measures 17" (43 cm). Wrist warmers: 6½" (16.5 cm) hand circumference; will stretch to fit hands up to 8½" (21.5 cm) around.

Yarn Ruth Huffman Designs American Buffalo 2 ply (100% American buffalo; 241 yd [220 m]/50 g): natural, 1 skein for neck warmer and 1 skein for wrist warmers.

Needles Neck warmer—Size 7 (4.5 mm): 24" (60-cm) circular (cir), and sizes 5 (3.75 mm) and 3 (3 mm): 16" (40-cm) cir. Wrist warmers—Size 5 (3.75 mm): set of 5 double-pointed (dpn). Adjust needle sizes if necessary to obtain the correct gauge.

Notions Markers (m); size D/3 (3.25 mm) crochet hook; tapestry needle; small amount of contrasting waste yarn.

Gauge 25½ sts and 40 rnds = 4" (10 cm) in rib pattern from Rnds 24–27 of Neck Warmer chart on size 3 (3 mm) needles. 26 sts and 28 rnds = 4" (10 cm) according to Wrist Warmer chart on size 5 (3.75 mm) needles.

Note

When shaping the wrist warmers above the thumb gusset, if there are not enough stitches to work both yarnovers and their companion k3tog, work the sts in garter st as for the rest of the pattern.

NECK WARMER

With size 7 (4.5 mm) cir needle, CO 144 (162) sts. Place marker (pm) and join for working in the rnd, being careful not to twist sts. Work Rnds 1–14 of Neck Warmer chart once, dec as indicated on Rnds 8 and 14—112 (126) sts rem. Change to size 5 (3.75 mm) needle. Work Rnds 15–21 of chart once, dec as indicated on Rnd 21—96 (108) sts rem. Rep Rnds 22–23 of chart until piece measures 3¾" (9.5 cm) from beg, ending with Rnd 23. Place waste yarn marker at end of last rnd. Change to size 3 (3 mm) needle. Rep Rnds 24–27 of chart until piece measures 1¼" (3.2 cm) from waste yarn marker, ending with Rnd 27. Change to size 5 (3.75 mm) needle. Work Rnds 28–31 of chart once. Rep Rnds 32 and 33 until piece measures 6¼" (16 cm) from beg. BO all sts very loosely knitwise.

Finishing

Top edging: With crochet hook, work shell patt across top edge of neck warmer as foll (see Glossary, page 106, for crochet instructions): Join yarn by working a sl st in a k3tog st, *skip next 2 sts, work 4 dc in next st, skip 2 sts, 1 sc in next st; rep from *, ending

last rep with sl st in sl st at beg of rnd. Fasten off. **Bottom edging:** With crochet hook, work shell patt and sc across lower edge of neck warmer as foll: Join yarn by working a sl st at the right side of a garter st section, *skip next 2 sts, work 4 dc in next st, skip 2 sts, 1 sc in st at left side of garter st section, 2 sc in yo space, 1 sc in k3tog st, 2 sc in next yo space, 1 sc in first st of next garter st section; rep from *, ending last rep with sl st in sl st at beg of rnd. Fasten off. Weave in loose ends. Agitate by hand in warm water with small amount of mild detergent for 4 to 6 minutes. Rinse thoroughly and blot with towel. Place in dryer on normal setting for 2 to 3 minutes. Lay flat on dry towel to finish drying. *Note:* May also be washed in washing machine foll instructions on yarn label.

WRIST WARMERS

Left Hand

With dpn, CO 42 sts. Divide sts as evenly as possible on 4 dpn, place marker (pm), and join for working in the rnd. Work Rnds 1–16 of Wrist Warmer chart, placing additional markers (m) after the 37th and 38th sts in last rnd for gusset placement. *Note:* For thumb gusset section, rep Rnds 15 and 16 for hand and work gusset sts between markers in garter st (knit 1 rnd, purl 1 rnd) to correspond to patt from chart. **Thumb gusset:** *Next rnd:* Cont in patt, work to first gusset m, slip marker (sl m), M1 (see Glossary, page 105), k1, M1, sl m, work to end—2 sts inc'd; 3 gusset sts between markers. Work 2 rnds even, working new sts in garter st. *Inc rnd:* Work to first gusset m, sl m, M1, work to next gusset m, M1, sl m, work to end—2 gusset sts inc'd between markers. Rep the last 3 rnds 4 more times, ending with Rnd 16—13 gusset sts between markers; 54 sts total. Work 2 rnds even. *Next rnd:* (Rnd 15 of chart) Cont in patt, work 38 sts, BO next 11 sts for thumb opening, work rem 5 sts (see Note)—43 sts rem. *Next rnd:* (Rnd 16 of chart) Cont in patt, use the backward loop method (see Glossary, page 104) to CO 3 sts over gap at thumb opening—46 sts rem. Work Rnds 17 and 18 as foll:

Rnd 17: Work in patt to last 9 sts, k2tog, k1, k2tog, work in patt to end—44 sts rem.

Rnd 18: Work in patt to last 8 sts, p2tog twice, work in patt to end—42 sts rem.

Work Rnds 19–23 in patt across all sts. BO all sts knitwise.

Finishing

Top edging: With crochet hook, work shell patt across top edge as foll (see Glossary, page 106, for crochet instructions): Join yarn by working a sl st in a k3tog st, *skip next 2 sts, work 4 dc in next st,



Neck Warmer

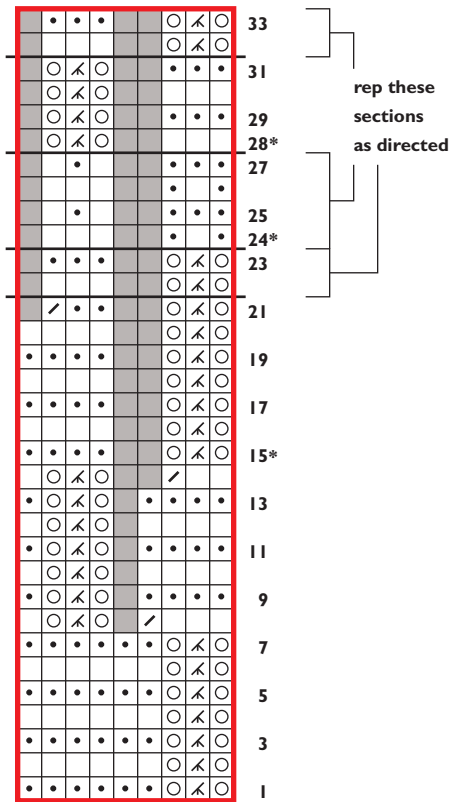

*change needle size

Wrist Warmer

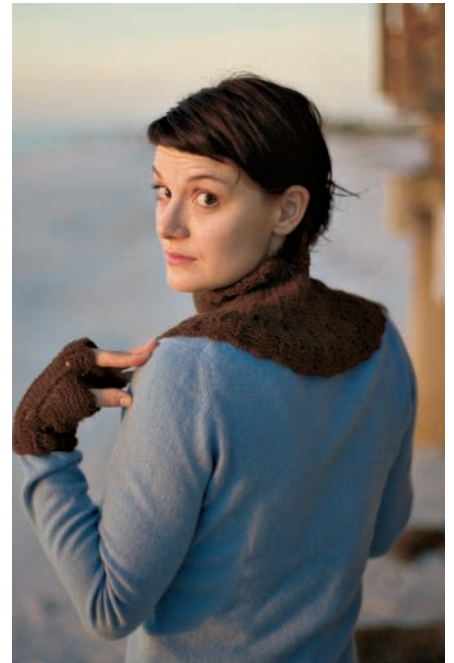
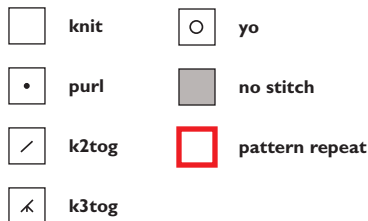
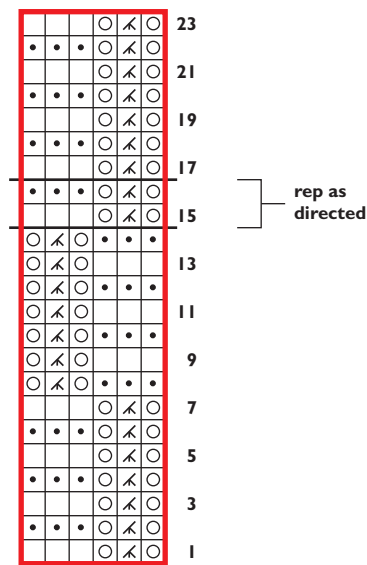

skip 2 sts, 1 sc in next st; rep from *, ending last rep with sl st in sl st at beg of rnd. Fasten off. **Bottom edging:** With crochet hook, work sc across lower edge as foll: Join yarn by working a sl st in lower edge at center of a garter st section, *skip next st, 2 sc in yo space, 1 sc in k3tog st, 2 sc in next yo space, 1 sc in center of next 3-st garter st section; rep from *, ending last rep with sl st in sl st at beg of rnd. Fasten off. Weave in loose ends. Wash and block as for neck warmer.

Right Hand

Work as for Rnds 1–16 of left hand, but place gusset markers after the 4th and 5th sts in last rnd. Work thumb gusset as for left hand, ending with Rnd 16—13 gusset sts between markers; 54 sts total. Work 2 rnds even. *Next rnd:* (Rnd 15 of chart) Cont in patt, work 5 sts, BO next 11 sts for thumb opening, work rem 38 sts—43 sts rem. *Next rnd:* (Rnd 16 of chart) Cont in patt, use the backward loop method to CO 3 sts over gap at thumb opening—46 sts. Work Rnds 17 and 18 as foll:
Rnd 17: Work first 4 sts, k2tog, k1, k2tog, work in patt to end—44 sts rem.
Rnd 18: Work first 4 sts in patt, p2tog twice, work in patt to end—42 sts rem. Work Rnds 19–23 in patt across all sts. BO all sts knitwise. Finish as for left hand. ∞

THERESE CHYNOWETH lives in Wauwatosa, Wisconsin, and works for Dale of Norway. She enjoys freelance designing in her spare time.

American Buffalo Products

by Ruth Huffman Designs

As seen in "Buffalo Girl" on page 72 of this issue

Ruth Huffman presents an exotic, and light weight fiber from a patented process for converting the hair of the American Buffalo into yarn.

Produced from a soft undercoat of down this yarn is very insulating and warm and can be washed or get wet without shrinking.

Rovings and yarn are being offered now in Bison Color, a rich chocolate brown. CREAMY WHITE AND BLACK are coming with this years new supply of buffalo hair and will be ready for the winter season.

ROVINGS: 2 oz. Size - \$20.00 per ounce

SPORT WEIGHT YARN - 1,000 ypp - 3ply - \$24.00 per ounce

LACE WEIGHT YARN - 2,000 ypp - 2ply - \$24.00 per ounce

Americanbuffaloproducts.com
800-501-4203

Pashmina™

100% Cashmere
(1/2 lb. cones)

available from:



Carolina Homespun

455 Lisbon Street, San Francisco, CA 94112
800-450-7786 (SPUN)
www.carolinahomespun.com

Great New Products



Electronic Row Counter
from Nancy's Knit Knacks
4 digit counter that adds and subtracts
battery included \$17.50



Forsyth Sock Yarn Warping Board
Make your own self striping sock yarn
\$45

1% For Peace

Carolina Homespun donates 1% of profits to support world peace

THE Web·sters



Rowan
Magazine #37
\$22.00 plus S&H

Order from our Website
www.yarnatwebsters.com

THE WEB·STERS

11 N. MAIN STREET
ASHLAND, OR 97520
1-800-482-9801
websters@mind.net

Lana Grossa
Debbie Bliss
Jo Sharp
Jamieson's
Rowan
Fiesta Yarns
Jaeger
Koigu
Trendsetter
Heirloom
Plymouth
Mission Falls
Brown Sheep
Vittadini
Manos
Colinette
Mountain Colors
Knit One, Crochet Two
Dale of Norway
Green Mountain
Berroco
Classic Elite
Prism
Noro
Brittany Needles
Anny Blatt
Great Adirondack
Philosopher's Wool
Tahki • Stacy Charles



ALCHEMY
YARNS OF TRANSFORMATION™
www.alchemyyarns.com

Teva Durham

INNOVATIVE ARTIST



Mimvea Durham

Most knit designers cite the traditional masters—Elizabeth Zimmermann, Nancy Thomas, Barbara Walker, perhaps Kaffe Fassett—as their mentors, or at least as a major source of inspiration. Teva Durham talks instead of being influenced by Karl Jung, Kurt Gödel, and Georges Braque.

She isn't being pretentious; she thinks about knitting the way art critics approach Eva Zeisel pottery or Tiffany stained glass—as a form more

art than craft, richly symbolic and complex in meaning. Forget the clichés about knitting being the new yoga, and banish from your head blogger chatter about A-list celebrities knitting between film takes. Instead, urges Teva, view the process and product of handknitting as an essential means of creative expression, “a gorgeous synthesis of structure and aesthetics, text and subtext.”

Durham's designs aren't just about creating something beautiful, or something functional, or something beautiful *and* functional. Rather, she says, a knitted garment “can infuse the wearer and the person who made it with something meaningful on more than one level. It's beautiful; it fits; the yarn feels nice against the skin; it's an original meditation on construction or ornament. And it somehow connects to big-picture themes—the history of art, costume design, mathematics, even anthropology.” These references are evident in many of her recent designs—a jacket that evokes the bodice worn over a farthingale (the Elizabethan hoopskirt), a leather-laced cowl whose exuberant sizing mimics the exaggeration of Renaissance lace collars, and chain-link scarves that are a post-modern (and wearable) take on the garlands kindergartners make with construction paper and library paste.

“I'm not a linear thinker, and I'm not a literal thinker, either,” Durham says over coffee at a coffeehouse near her apartment in Manhattan's Hell's Kitchen. The rooms in her home are tiny, but space is used ingeniously, like a well-made yacht—lots of built-ins and storage that doubles as seating. Her studio is on the upper level, along with a bedroom whose angled glass ceiling evokes Parisian garrets. Yarn, stored in open shelving and juxtaposed with a dressmaker's dummy, looks a bit like an art installation. “I'm always looking to see how things are connected, and how shapes and themes resonate with people.” To Durham's way of thinking, incorporating cultural archetypes into her work encourages this res-

onance because archetypes hold significance for people—we're hardwired to appreciate images of things that appear in nature and get repeated in things handmade. So a Möbius scarf symbolizes infinity, and shapes—circles, curves, waves, ridges, spirals—whether knitted in intarsia or in relief, symbolize organic elements.

Not that Durham is all seriousness about knitting. She laughs when she tells the story of the sample knitter who called to report that all her friends thought Teva's design was ugly. She jokes about the calming effect of knitting when she was in the middle of an all-nighter to meet a deadline and realized, with her infant daughter on her breast, that she had to rip out ten hours' worth of work on a fourteen-color Fair Isle sweater because she'd made an uncorrectable mistake. A chat with Durham is unpredictable: Her theatrical training (see backstory) animates her delivery, and her conversation meanders into thickets of asides before swinging back on point. Throw in her sly sense of humor, and you appreciate exactly how Durham can get away with comparing the knitting of an oversized bobble with the making of a homemade meatball.

The meatball bit appears in *Loop-d-Loop* (Stewart, Tabori & Chang, 2005) a collection that bears the same name as the online knit boutique (www.loop-d-loop.com) Durham opened in 2000. Her online collection, mostly in chunky yarns and knitted on circular needles, is the launching point for Teva's book.

Where some designers become known for a particular, striking style—fancy cablework, riotous colorwork, intricate floral intarsia, form-fitting cardigans—the designs in *Loop-d-Loop* cover a breadth of genres. The only feature that links a glove, a reversible double-knit vest, a corrugated hat, a slipcover for a café chair, and a child's chenille sweater is Durham's ability to interpret each piece in a wholly original way. In her Fair Isle short-row pullover, every other patterned band curves upward toward the shoulder, unexpectedly and gracefully; the puff-sleeve bolero is a cheeky cross between a Spencer jacket and a shrug.

Visually, the book is a confection that showcases Durham's omnibus talents. She wrote the copy and drafted the patterns. She styled the photoshoot with her eclectic wardrobe, selected a photographer—a man better known for edgy art than for commercial photography—and mixed professional models with her enlistments, among them her sister, her rambunctious three-year-old daughter, the father of one of her daughter's playmates, and a striking woman in her seventies who was spotted the day before the shoot in a delicatessen. “I want-

ed real people to model, with real figures, not necessarily tall, stick-thin mannequins,” she explains. The photographs are quiet and sensual, but they show respect for the garment’s construction—for which Durham always takes care to provide the structural details a knitter finds useful in hands-on knitting. The book is not just coffee-table eye candy.

Editorially, too, the book is a treat. Durham has written lengthy and often poignant intros to each piece, explaining how she approached the design, who (relative, friend, acquaintance) inspired a choice she made in color, shape, or function, and how the design evolved as she experimented with texture, yarn choices, and construction options. You’ll learn how the corkscrew scarf began life as a mistake in a short-row hat; how the fringe in the “castaway” sweater was knitted on rather than applied so it could look like dreadlocks from “the fleece of a wild, wayward sheep”; how, by putting the cables in the riding jacket on the bias and twisting them frequently, she was able to produce a flattering hourglass silhouette. The idea for the zip-off color-block sweater was triggered by a memory of one of the most provocative images from Durham’s childhood—her brother’s *Sticky Fingers* album, the one with the jeans “with a real, working zipper sewn down the fly.” It took Durham several years of plotting before she came up with a design that looked good on both sexes—and just as good zipped as unzipped.

Rather than distracting from the story lines of the garments, these reminiscences connect the reader to Durham’s life, in the world of knitting and without.

The backstory

When it comes to design, Teva Durham knows instinctively how to make a garment work. When it comes to designing a life, it’s been a harder slog.

Now forty-one, Durham was born and raised in St. Louis, one of four children of fine artists. She grew up surrounded by her parents’ intellectual set; by folk music, lots of books, and artwork in all media, and very little TV. From an early age she felt “driven to make things and to think about making things—I wrote a family newspaper, ironic rather than objective, when I was a kid.” But there was an difficult divorce. Her mother left the Midwest to pursue an artist’s life in New York, and Durham and her siblings remained with their father. At fourteen, Durham moved to New York to attend the High School of Performing Arts, the one dramatized in the film and TV series *Fame*. Shy by tem-

perament, she loved losing herself in character, emboldened rather than intimidated by performing on stage. After graduation, she briefly attended Swarthmore College, but left school in her freshman year. Youthful adventures (and misadventures) followed: a stint studying Shakespeare at the Royal Academy of Dramatic Arts in London, au pairing in Paris, and running off to Morocco with her fiancé, then back to acting school in New York.

But the business of acting wasn’t so appealing. “I was doing good work until I started worrying about whether I could play the ingenue or had to stick to being a character actress. There was too much emphasis on how I looked and how I had to market myself.” In her mid-twenties she became ambivalent about

her acting career. When she wasn’t taking a scene study or playwriting workshop, or proofreading for a living, she spent “every spare moment knitting—a different kind of refuge than acting, but one that I craved.” She bought a knitting machine and began designing knitwear for private clients, more for the challenge of making things than to support herself. A degree in English followed, then a job as a reporter for a garment-industry trade magazine, then a job as a fashion forecaster. In 1997, she was hired as an editor by *Vogue Knitting*. “A dream job,” she says, smiling, “because it combined the two things I love most, designing and writing.” An internship in the design room of Dana Buchman followed, just before Durham launched *Loop-d-Loop*.



Chris Hartove



Adrian Buckmaster



Clockwise: Fair Isle pullover with short rows (Loop-d-Loop); Leaf Cravat from Interweave Knits Winter 2002/03; sleeveless pullover with center shaping (Loop-d-Loop).

Balancing the demands of entrepreneurship, single parenthood, and the labor-intensive and not terribly lucrative fields of writing and designing has been tough. “I do have these moments when I totally panic,” Durham admits. “The anxiety about making ends meet is pretty constant.” But she’s feeling good about the new book, and she knows that its reception will help determine the next phase of her career. “Looking back at all the struggle and uncertainty and insecurity, I can now see that I’m in exactly the right place, doing exactly what I should be doing.” She laughs, sweetly. “Dare I say it? The planets feel aligned.”

Julie Moline is a freelance writer based in New York who writes about travel, food and design.

LACE LEAF PULLOVER

design by TEVA DURHAM



THE SWEATER BODY OF THIS COMFY, OVERSIZED PULLOVER is constructed in two pieces, allowing the leaf motif to extend from the ribbing of each piece. The lower half is worked from the hem up, the upper half is worked from the top down (partially in rows, partially in rounds), and then the pieces are grafted together. The sleeves are worked from the cuff upward and grafted to the saddle shoulders. This project is from Teva's new book *Loop-d-Loop* (Stewart, Tabori & Chang, 2005).

Finished Size 38 (42, 46)" (96.5 [106.5, 117] cm) bust circumference. Sweater shown measures 38" (96.5 cm).

Yarn Filtes King Van Dyck (46% wool, 39% acrylic, 15% alpaca; 117 yd

[107 m]/100 g): #165 green heather, 5 (6, 7) balls. Yarn distributed by Needful Yarns.

Needles Size 13 (9 mm): 24" (60-cm) and 32" (80-cm) circular (cir). Adjust needle size if necessary to obtain the correct gauge.

Notions Markers (m); stitch holders or spare cir needle; tapestry needle; ½" × 1" (1.3 cm × 2.5 cm) toggle button.

Gauge 10 sts and 14 rows = 4" (10 cm) in St st.

Note

When working in rnds, read the chart from right to left for every rnd (every other rnd is knit even); when working the chart in rows (on upper body and left sleeve), read RS rows from right to left and read WS rows from left to right (all WS rows are purled).

Lace Leaf

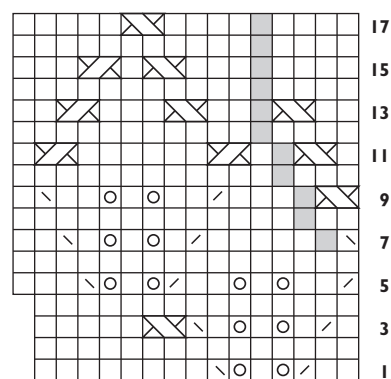

- k on RS; p on WS
- k2tog
- ssk
- yo
- no stitch
- RT: Knit into second st but leave st on 1st needle, knit first st, then slip both sts off needle
- LT: Knit into back loop of second st on left needle but leave st on needle, knit into first st, then slip both sts off needle

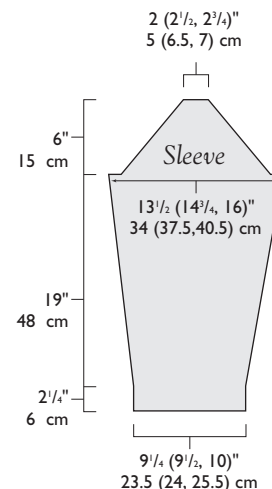
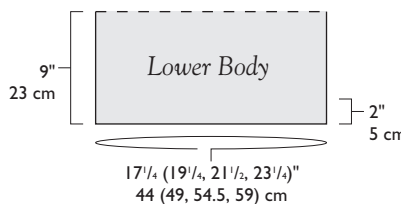
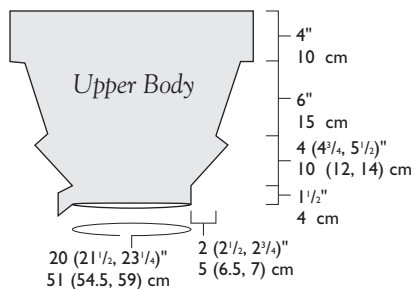

Stitch Guide

Twisted Rib: (worked in rounds or rows)

Rnd/Row 1: *K1 through back loop (tbl), p1 tbl; rep from *, ending k1 tbl if there are an odd number of sts.

Rnd/Row 2: Work the sts as they appear through the back loop (knit the knits tbl and purl the purls tbl).

Repeat Rnd/Row 2 for pattern.

Lace Panel: (worked over 7 sts)

Row 1: (RS) Yo, k2tog, k3, ssk, yo.

Row 2: Purl.

Repeat Rows 1 and 2 for pattern.

Lower Body

With longer cir needle and using the long-tail method (see Glossary, page 104), CO 96 (102, 108) sts. Place marker (pm) and join for working in the rnd, being careful not to twist sts. Rnd begins at left side seam. Work twisted rib (see Stitch Guide) for 7 rnds. *Set-up rnd:* K25 (26, 27), pm, k15 for leaf panel, pm, k8 (10, 12), pm (right side seam), k48 (51, 54) sts for back. Working 15 sts between markers according to Leaf chart and rem sts in St st (knit every rnd), work Rows 1–17 of Leaf chart. Change to St st on all sts until piece measures 9" (23 cm). Place sts on holder or spare needle, keeping markers for side seams (or you can knit a few rows with scrap yarn and bind off)—later the live sts will be grafted to the BO edge of the upper body.



Adrian Buckmaster

Upper Body

With shorter cir needle and using the long-tail method, CO 54 (58, 62) sts. Do not join into a rnd. Beg with a WS row, work twisted rib for 2 rows. **Buttonhole row:** (WS) K1 tbl, p1 tbl, yo, k2tog, work to end as established. Work 3 rows even in twisted rib, ending with a RS row. **Buttonhole tab:** (WS) BO 4 sts, purl to end—50 (54, 58) sts. **Next row:** (inc row) K5 (6, 7), pm for left back shoulder, k1f&b, k18 (19, 20) for back neck, k1f&b, pm for right back shoulder, k5 (6, 7), pm for right front shoulder, k1f&b, k6 (7, 8), pm, work Row 1 of Leaf chart (only 12 sts remain, but incs will accommodate remainder of chart) to last st, k1f&b, pm, join for working the rnd, being careful not to twist sts—54 (58, 62) sts. Knit 1 rnd, slipping markers (sl m). **Next rnd:** (inc rnd) K5 (6, 7), sl m for left back shoulder, k1f&b, k20 (21, 22) for back neck, k1f&b, sl m for right back shoulder, k5 (6, 7), sl m for right front shoulder, k1f&b, k7 (8, 9), sl m, work

Row 3 of Leaf chart, k1f&b. Work 1 rnd even. Cont in patt as established, and inc 1 st at each shoulder m every other row a total of 5 (6, 7) times (last inc rnd will be Rnd 9 [11, 13] of chart)—70 (78, 86) sts. **Dividing row:** (WS; would be a knit-even rnd from RS) Turn work and p30 (33, 36), leaving yarn hanging in preparation to work a RS row, place next 5 (6, 7) sts on holder for shoulder (these will be grafted to top of sleeves), join new yarn, p30 (33, 36), place rem 5 (6, 7) sts on holder for other shoulder. Working each section separately, cont as established through end of chart, and *at the same time*, inc 1 st each side every 4th row 5 times, ending with a WS row—40 (43, 46) sts; 20 rows worked. **Joining rnd:** (RS) Work across first section, use the backward loop method (see Glossary, page 104) to CO 8 sts for underarm, work to end, the BO 8 more sts for other underarm, and rejoin for working in the rnd—96 (102, 108) sts. Work even in St st for 4" (10 cm) more. BO all sts.

Left Sleeve

With shorter cir needle and using the long-tail method, CO 23 (24, 25) sts. Do not join into a rnd. Beg with a WS row, work twisted rib for 8 rows. Purl 1 WS row. **Set-up row:** (RS) K4 (4, 5), pm, work Row 1 of Leaf chart over center 15 sts, pm, k4 (5, 5). Cont as established, working sts on each side of chart in St st, for 7 rows. **Inc row:** (RS) Inc 1 st at each end of needle—2 sts inc'd. Work 7 rows even. Rep the last 8 rows 4 (6, 6) more times—33 (36, 39) sts. Work even in patt until piece measures 19" (48.5 cm) from beg, ending with a WS row. **Shape cap:** BO 4 sts beg of next 2 rows—25 (28, 31) sts rem. Dec 1 st each end of needle every RS row 10 (9, 8) times, then every row 0 (2, 4) more times as foll: Work the decs on 2nd and 3rd sts in from edge using right slant (k2tog on RS; p2tog on WS) on RH side of piece, and left slant (ssk on RS; ssp on WS) on left side, end with a WS row—5 (6, 7) sts rem. Place sts on holder.

Right Sleeve

Work as for left sleeve, but instead of working Leaf chart on center 15 sts, work lace panel (see Stitch Guide) on center 7 sts, working **Set-up row as foll:** (RS) K8 (8, 9), pm, work Row 1 of lace panel over center 7 sts, pm, k8 (9, 9).

Finishing

With yarn threaded on a tapestry needle and using the Kitchener st (see Glossary, page 105), graft lower body to upper body, centering side seam along 8 underarm sts of upper body. Sew sleeve seams. Sew sleeves into armholes, using the Kitchener st to graft 5 (6, 7) held sleeve sts to 5 (6, 7) held shoulder sts. Sew button to collar rib at left shoulder. ∞

FAN CLUTCH AND FUN FUR COLLAR

design by LISA DAEHLIN
AND KATY RYAN

NEED SOMETHING SNAZZY for a special night on the town? Carry your glamour kit in Lisa Daehlin's classy clutch. The back and front are worked in short row stripes that give the bag its vintage fan shape. The gusset strip wraps around all three sides of the purse and forms pretty scallops along the bottom. A large snap on the inside holds the bag closed, so choose a favorite button to decorate the outside. After finishing, an optional (but suggested) fabric lining can be sewn in. To keep your shoulders warm, and add color and contemporary style to that little black dress, wear Katy Ryan's brief Fun Fur capelet. It's worked with a triple strand of yarn—only 19 rows from start to finish.

Finished Size Clutch: About 7½" (19 cm) wide across opening at top, 16" (40.5 cm) wide across bottom edge, and 7½" (19 cm) high, with 2" (5-cm) gusset around sides and bottom. Collar: About 36" (91.5 cm) wide along lower edge and 4¼" (11 cm) high, unstretched.

Yarn Clutch: Lion Brand Cotton-Ease (50% cotton, 50% acrylic; 207 yd [189 m]/100 g): #153 licorice (black) and #102 bubblegum (pink), 1 ball each. Collar: Lion Brand Fun Fur (100% polyester; 64 yd [58 m]/50 g): #101 soft pink, 6 balls (used triple).

Needles Clutch: Size 3 (3.25 mm). Collar: Size 13 (9 mm). Adjust needle size if necessary to obtain the correct gauge.

Notions Tapestry needle; removable stitch markers or safety pins; decorative antique button (any size), ½" (1.3-cm) heavy-duty snap, and ½ yd (0.5 m) black fabric for lining (optional) for clutch; 2 yd (2 m) black grosgrain ribbon 1½" (3.8 cm) wide for collar; sharp-pointed sewing needles and thread for attaching snap, lining, and ribbon.

Gauge Clutch: In fluted lace patt for back and front, 18½ sts = 4" (10 cm) wide; each 10-row patt rep measures about 1¼" (3.2 cm) high along lacy sawtooth edge at beg of RS rows, and about ⅝" (1.6 cm) high along garter ridges at end of RS rows. Collar: 9½ sts and 18 rows = 4" (10 cm) in garter st with yarn tripled.

CLUTCH

Back and Front (make 2)

With black and using the long-tail method (see Glossary, page 104), CO 33 sts. Work fluted lace patt as foll:

Set-up row: (WS) K6, p19, [yo, k2tog] 3 times, yo, k2—34 sts.

Row 1: (RS) Knit to last 6 sts, turn (last 6 sts remain unworked).

Row 2: Sl 1 kwise with yarn in back (wyb), p19, [yo, k2tog] 3 times, yo, k2—35 sts.

Row 3: K29, turn (last 6 sts remain unworked).

Row 4: Sl 1 kwise wyb, k20, [yo, k2tog] 3 times, yo, k2—36 sts.

Row 5: K9, p21, turn (last 6 sts remain unworked).

Row 6: Sl 1 kwise wyb, k1, [yo, k2tog] 13 times, yo, k2—37 sts.

Row 7: K9, p22, k6.

Row 8: K29, [yo, k2tog] 3 times, yo, k2—38 sts.

Row 9: BO 5 sts with black, change to pink, knit to end—33 sts rem.

Row 10: K6, p19, [yo, k2tog] 3 times, yo, k2—34 sts.

Row 11: Knit to last 6 sts, turn (last 6 sts remain unworked).

Row 12: Sl 1 kwise wyb, p19, [yo, k2tog] 3 times, yo, k2—35 sts.

Row 13: Change to black. K29, turn (last 6 sts remain unworked).

Row 14: Sl 1 kwise wyb, k20, [yo, k2tog] 3 times, yo, k2—36 sts.

Row 15: K9, p21, turn (last 6 sts remain unworked).

Row 16: Sl 1 kwise wyb, k1, [yo, k2tog] 13 times, yo, k2—37 sts.

Row 17: K9, p22, k6.

Row 18: K29, [yo, k2tog] 3 times, yo, k2—38 sts.

Rep Rows 9–18 *only* 11 more times, ending with Row 18—129 rows, including set-up row; 12 pink stripes completed; 13 raised black eyelet sections (Rows 4–8 or Rows 14–18) completed. *Next row:* (RS) With black, BO 5 sts, knit to end—33 sts rem. *Next row:* K6, p19, [yo, k2tog] 3 times, yo, k1, sl 1 pwise wyf—34 sts. BO all sts with black.

Gusset for Sides and Bottom

With black and using the long-tail method, CO 9 sts.

First side:

Row 1: (RS) K3, p3, k3.

Row 2: (WS) P3, k3, p3.

Rep Rows 1 and 2 until piece measures 7¼" (19.5 cm) from beg, ending with a WS row. Mark each end of last row completed to indicate position of bottom corners.

Bottom: Cont on 9 sts as foll:

Row 1: (RS) Knit.

Rows 2 and 3: Work in rev St st (purl on RS rows, knit on WS rows).

Row 4: (WS; picot fold line) K2, [yo, k2tog] 3 times, k1.

Rows 5 and 6: Work 2 rows in rev St st.

Row 7: (RS) Fold strip along picot fold line of Row 4 with WS touching. *Insert right needle tip into next st on needle, then use tip of right needle to lift the purl bump of the same st 6 rows below from Row 1 onto the left needle, then purl the st and the lifted strand tog; rep from * across to create a tuck on RS.

Rows 8–11: Work in rev St st, ending with a RS row.

Rows 12 and 13: Work in St st (knit on RS rows, purl on WS rows).

Rows 14–18: Work in rev St st.

Rep Rows 1–18 eleven more times, then work Rows 1–7 once more—13 tucks. Mark each end of last row completed to indicate position of bottom corners of bag.

Second side:

Row 1: (WS) P3, k3, p3.

Row 2: K3, p3, k3.





Yarns
Sweaters
Patterns
Ceramic Buttons



FROG TREE
COLLECTION

508 385-8862

Alpaca
Merino
Pima Cotton
Pima Cotton/Silk

T&C IMPORTS
A NOT-FOR-PROFIT COMPANY • FAX: 508 385-9476
tandcimports@comcast.net • P.O. BOX 1119, EAST DENNIS, MA 02641



Rep the last 2 rows until piece measures $7\frac{3}{4}$ " (19.5 cm) from last set of markers. BO all sts.

Finishing

Lining: (optional) Using knitted pieces as templates, cut front, back, and gusset pieces from lining fabric $\frac{1}{2}$ " (1.3 cm) bigger all the way around for seam allowances. With black yarn threaded on a tapestry needle, sew gusset strip between back and front halves of bag, matching gusset markers to lower corners of bag, centering each bottom tuck on a raised black eyelet section of front and back, and easing to fit. Weave in loose ends. With sewing needle and thread, sew lining pieces together as for bag. Sew each half of snap closure in the center of the back or front, about $1\frac{1}{2}$ " (3.8 cm) down from the top edge. Fold top edge of lining down $\frac{1}{2}$ " (1.3 cm). With WS touching, sew lining and purse together around top opening. Bring front and back together at each side of top opening, forming a pleat with the gusset strip 1" (2.5 cm) deep. With double strand of black yarn threaded on tapestry needle, tack pleat in place. Sew decorative button to outside of purse, positioned over the snap.

FUN FUR COLLAR

With 3 strands of yarn held tog, CO 86 sts. Work garter st (knit every row) for 6 rows. *Dec Row 1:* K8, k2tog, k1, ssk, k17, k2tog, k1, ssk, k16, k2tog, k1, ssk, k17, k2tog, k1, ssk, k8—78 sts rem. Work 5 rows even in garter st. *Dec Row 2:* K7, k2tog, k1, ssk, k15, k2tog, k1, ssk, k14, k2tog, k1, ssk, k15, k2tog, k1, ssk, k7—70 sts rem. Work 5 rows even in garter st. *Dec Row 3:* K6, k2tog, k1, ssk, k13, k2tog, k1, ssk, k12, k2tog, k1, ssk, k13, k2tog, k1, ssk, k6—62 sts rem; 19 rows completed. BO all sts.

Finishing

Weave in loose ends. Cut two 25" (63.5-cm) ties from ribbon. Trim across one end of each tie at a 45-degree angle. With sewing needle and thread, sew the straight (not angled) end of each tie to short end of collar. ∞

LISA DAEHLIN is an opera singer, milliner, and knitter who lives in New York. KATY RYAN is a writer and knitter in Maine.

Exquisite plant-dyed yarns



La Lana Wools



Strappy Summer Top by Linda Romens



Phling around some Phat Silk this season.
Silk with Memory Wool with Lustre

Visit our Phat Silk Collection at www.lalanawools.com

136 Paseo Norte • Taos • NM 87571
Orders: 888-377-9631 • Info: 505-758-9631



Montat Publishing

books, software, & more . . . for the handknitter
www.Montat.com

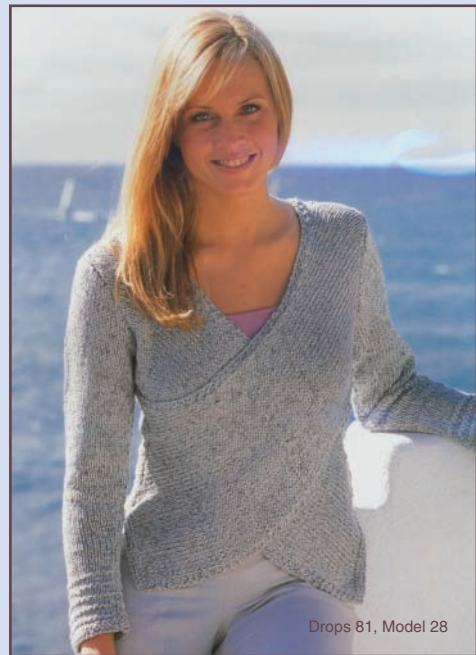

Drops 81, Model 28

GARNSTUDIO Yarns and DROPS Design
 Scandinavia's most exciting yarns & patterns now available
 throughout North America! For dealer information, please contact:

AURORA YARNS

PO Box 3068, Moss Beach, CA 94038 USA
 tel 650-728-2730 fax 650-728-8539
 email: aurorayarns@pacbell.net

**FREE
 Full-Color Catalog!!**

Order Toll Free
1-800-933-9665
www.woolconnection.com

**THE
 WOOL CONNECTION**

34 E. Main Street, Avon, CT
 E-mail: wool@tiac.net

Jeweled Lace Poncho Kit

Original designs
 by
 Adrienne Welch

Perfect for Spring
 or Summer ~~~



See our
 Elegant Poncho Kit at



www.ArachneDesigns.net

adriennewelch@arachnedesigns.net
 314.761.7196

SLEEK RIBS TANK

design by THERESE CHYNOWETH

THERESE CHYNOWETH USES COLUMNS OF DECREASES AND INCREASES in a one-by-one rib pattern to create a dramatic chevron design for an otherwise straightforward tank. The back, worked in simple, vertical ribs, follows the natural tendency of ribbed fabric to draw in for a close fit. The body of the tank is worked in the round to the armholes, then the front and back are divided and worked separately (back and forth in rows) to the shoulders. The straps crisscross in the back for a secure fit.

Finished Size 28¼ (32, 35¼, 39½, 44½)" (72 [81.5, 91, 100.5, 113] cm) chest/bust circumference. Top shown measures 32" (81.5 cm).

Yarn Berroco Denim Silk (20% silk, 80% rayon; 105 yd [97 m]/50 g): #1404 carob, 4 (4, 5, 6, 7) skeins.

Needles Size 7 (4.5 mm): 24" (60-cm) circular (cir) and set of 2 double-pointed (dnp). Adjust needle size if necessary to obtain the correct gauge.

Notions Markers (m); stitch holder; size G/6 (4 mm) crochet hook; tapestry needle.

Gauge 25 sts and 28 rnds = 4" (10 cm) in rib pattern worked in the round.

Body

With cir needle, CO 186 (210, 234, 258, 290) sts. Place marker (pm) and join for working in the rnd, being careful not to twist sts.

Rnds 1–3: Work k1, p1 rib, placing 5 markers on first rnd as foll:

Work 3 (5, 7, 9, 13) sts, pm, work 22 (24, 26, 28, 30) sts, pm, work 21 (23, 25, 27, 29) sts, pm, work 23 (25, 27, 29, 31) sts, pm, work 21 (23, 25, 27, 29) sts, pm, work to end.

Rnds 4 and 6: Cont in rib, work to first m, slip marker (sl m), *yo, work to 2 sts before next m, sl 2 sts tog kwise, remove m, k1, p2sso, pm, work to next m, yo, sl m, k1; rep from * once, work to end in rib.

Rnd 5: Work in established rib, working each yo as k1.

Rnd 7: Work in established rib, working each yo as p1.

Rep Rnds 4–7 until piece measures about 8½ (9, 9½, 9¾, 10)" (21.5 [23, 24, 25, 25.5] cm) from beg, ending with Rnd 5 or 7 of patt.

Shape sides: Cont in patt as established, work short rows across front and sides only as foll:

Row 1: (RS) Work in patt to last front m, work 15 (19, 23, 27, 33) sts in rib, turn.

Row 2: Sl 1, work in patt to last front m (m just before beg-of-rnd m), work 15 (19, 23, 27, 33) sts in rib (pass beg-of-rnd m as you do so), turn.

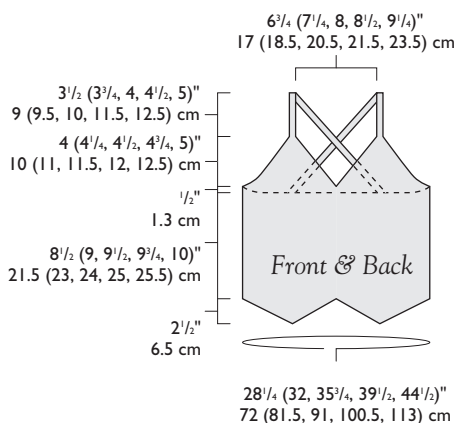

Rows 3 and 4: Sl 1, work in patt to last front m, work 10 (13, 16, 19, 23) sts in rib, turn.

Rows 5 and 6: Sl 1, work in patt to last front m, work 6 (8, 10, 12, 15) sts in rib, turn.

Rows 7 and 8: Sl 1, work in patt to last front m, work 3 (4, 6, 6, 9) sts in rib, turn.

Rows 9 and 10: Sl 1, work in patt to last front m, work 1 (1, 2, 2, 4) sts in rib, turn.

Row 11: Sl 1, work in patt to last front m, BO all sts to end of rnd, then BO all sts to first m—87 (95, 103, 111, 119) sts rem.

Front

With RS facing, work 20 (22, 24, 26, 28) sts in rib, sl 2 sts tog kwise, k1, p2sso, work next 20 (22, 24, 26, 28) sts, BO 1 st, work 20 (22, 24, 26, 28) sts, sl 2 sts tog kwise, k1, p2sso, work rem 20 (22, 24, 26, 28) sts—82 (90, 98, 106, 114) sts rem. Place first 41 (45, 49, 53, 57) sts onto holder for left front. Work 41 (45, 49, 53, 57) right front sts as foll: Work 19 (21, 23, 25, 27) sts, sl 2 sts tog pwise through back loop (tbl), place these 2 sts back onto left needle and p3tog, work rem 19 (21, 23, 25, 27) sts—2 sts dec'd. Cont working dec at center of every row until 5 sts rem, changing to dnp if desired. Work 4 rows even in patt. Dec on next row as before—3 sts rem. **Strap:** Cont in established rib until strap measures about 14 (15, 16, 18, 20)" (35.5 [38, 40.5, 45.5, 51] cm) from beg. BO all sts. Place 41 (45, 49, 53, 57) held left front sts on needle and work as for right front.

Finishing

Back edging: With RS facing, work 1 row of single crochet (see Glossary, page 106, for crochet instructions) across BO sts on back, working in knit sts only. With RS still facing, work 1 row of reverse single crochet on top of previous row of crochet. Fasten off. Divide back into thirds and mark position for strap placement. With yarn threaded on a tapestry needle, sew free end of right shoulder strap to left back and free end of left strap to right back at marked positions, placing straps behind crochet edging. Weave in loose ends. Block lightly to measurements. ∞

THERESE CHYNOWETH is an avid, mostly self-taught knitter. She particularly enjoys technical knitting and "engineering" her designs.



BACK BY POPULAR DEMAND!

INTERWEAVE KNITS
CROCHET
2005

a SPECIAL ISSUE devoted to
the creative possibilities of crochet

- All the features you like in *Knits*
 - **Techniques** and **how-to**
 - **New** exclusive designs to make
 - **Scrumptious** yarns • **Fresh** looks
 - Gifts • **Wearables** • Décor
- And much more!

112 pages, \$7.99 US, \$9.99 Canada

on sale
Sept. 7
\$7.99

**Hook yourself
a copy today!**

Call **(800) 272-2193**

or purchase your issue online at
www.interweaveknits.com



Left: Lace Dress; Above: Cranesbill
Square Blouse. Both from
Interweave Knits Crochet 2004

Didn't get
your copy of
Crochet 2004?

available
NOW!



Interweave Knits Crochet 2004
\$7.99 US, \$9.99 Canada



INTERWEAVE PRESS.

New from Fiddlesticks Knitting!

The Natural Collection, beautiful patterns featuring Infiknit's Ecolnit organic cotton, the soft, natural choice for comfortable knits.



Collection available at www.fiddlesticksknitting.com.

Wholesale inquiries welcome. Visit www.infiknit.com, e-mail info@infiknit.com or call toll-free 800-408-1522.



Needlepoint Joint

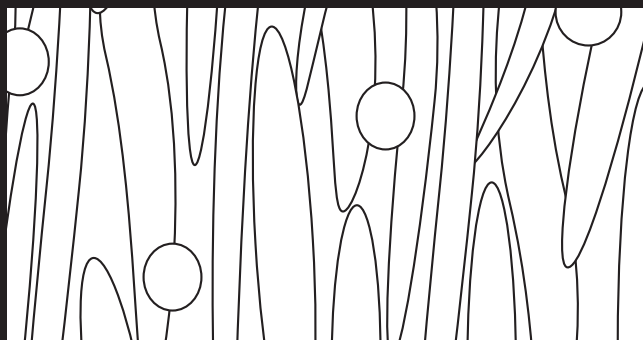

Supplies for knitting, crochet and all types of needlework!

241 Historic 25th St., Ogden, UT 84401

☎ (801) 394-4355

www.needlepointjoint.com

addi Turbo® needles

the choice of professional knitters

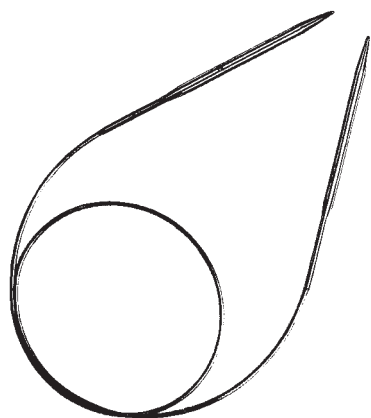

Slick tips, smooth joints and pliable cords have made the addi Turbo® circular needle the choice for professional knitters for years! Isn't it time you joined them?

Available in 8 lengths from 12" to 60" and in 19 sizes ranging from a US 000 to a US 36.

available in fine yarn shops

Exclusive Distributor

skacel collection, Inc.

PO Box 88110, Seattle, WA 98138-2110

Phone: (425) 291-9600



A Second Treasury of Magical Knitting



by
Cat Bordhi

Ask for the book at your local yarn shop, or visit www.CATBORDHI.COM for a preview of both *Treasuries*, Cat's workshop schedule, and free knitting patterns.

DYLAN GOES ELECTRIC

design by KAREN BAUMER

KAREN BAUMER GREW UP LISTENING TO CLASSICAL MUSIC, but as an adult she came to appreciate popular music, especially the work of Bob Dylan. The title of this sweater refers to the pivotal moment at the Newport Folk Festival in 1965 when he “went electric.” For Karen, the wavy ribs represent the vibration of electric guitar strings, as well as the shock waves that ensued when Dylan broke with acoustic tradition and plugged in his guitar. The back, front, and sleeves are knitted separately. The simple funnel neck makes for a classic, comfy shape that is sure to bring rave reviews.

Finished Size 34 (38, 42, 46, 50)" (86.5 [96.5, 106.5, 117, 127] cm) chest/bust circumference. Sweater shown measures 42" (106.5 cm).

Yarn Cascade Sierra (80% cotton, 20% wool; 191 yd [175 m]/100 g): #62 kelp, 7 (8, 9, 10, 11) skeins.

Needles Body and Sleeves—Size 7 (4.5 mm): straight. Edging—Size 6 (4 mm): straight and 16" (40-cm) circular (cir). Adjust needle size if necessary to obtain the correct gauge.

Notions Stitch holders; markers (m); cable needle (cn); tapestry needle.

Gauge 26 sts and 26 rows = 4" (10 cm) in waving rib patt from chart on larger needles, lightly blocked; 19½ sts and 26 rows = 4" (10 cm) in k2, p3 rib on larger needles, lightly blocked.

Back

With smaller straight needles, CO 101 (111, 121, 131, 141) sts. *Next row:* (WS) K2, *p2, k3; rep from * to last 4 sts, p2, k2. Cont in rib as established until piece measures 3" (7.5 cm), ending with a WS row. Change to larger needles and work established rib for 2 more rows. *Next row:* (RS) Work 12 (17, 22, 27, 32) sts in rib as established, place marker (pm), work center 77 sts according to Row 1 of Waving Rib chart (see page 90), pm, work 12 (17, 22, 27, 32) sts in rib as established. Cont in patts as established until 24-row patt from chart has been worked a total of 2 (2, 3, 3, 3) times, then work Rows 1–18 (24, 10, 10, 18) of chart once more—piece should measure about 13½ (14½, 16, 16, 17¼)" (34.5 [37, 40.5, 40.5, 44] cm) from CO. **Shape armholes:** BO 5 sts at

beg of next 2 rows—91 (101, 111, 121, 131) sts rem. Dec 1 st each end of needle every row 4 (9, 9, 14, 14) times—83 (83, 93, 93, 103) sts rem; 3 purl sts at each end of RS rows. Cont even until armholes measure about 8¼ (8¾, 9½, 9½, 10)" (21 [22, 24, 24, 25.5] cm), ending with Row 23 (11, 23, 23, 11) of chart—119 (131, 143, 143, 155) chart rows completed. **Shape shoulders:** Working all sts in k2, p3 rib as established (do not cont charted patt), BO 6 (6, 9, 9, 11) sts at beg of next 2 rows, then BO 7 (7, 9, 9, 10) sts at beg of foll 2 rows, then BO 8 (8, 8, 8, 10) sts at beg of foll 2 rows—41 sts rem. Place sts on holder.

Front

Work as back.

Sleeves

With smaller straight needles, CO 52 (52, 57, 57, 62) sts. *Next row:* (WS) P2, *k3, p2; rep from * to end. Cont in rib as established until piece measures 2½" (6.5 cm), ending with a WS row. Change to larger needles. Cont in established rib, and beg with the next RS row, inc 1 st each end of needle every 4 rows 20 (24, 25, 25, 26) times, working new sts into k2, p3 rib—92 (100, 107, 107, 114) sts; piece should measure about 15 (17¼, 18, 18, 18½)" (38 [44, 45.5, 45.5, 47] cm) from beg. Cont even in patt until piece measures 17 (18, 19, 19, 19½)" (43 [45.5, 48.5, 48.5, 49.5] cm) from beg, ending with a WS row. **Shape cap:** BO 5 sts at beg of next 2 rows—82 (90, 97, 97, 104) sts rem. Dec 1 st each end

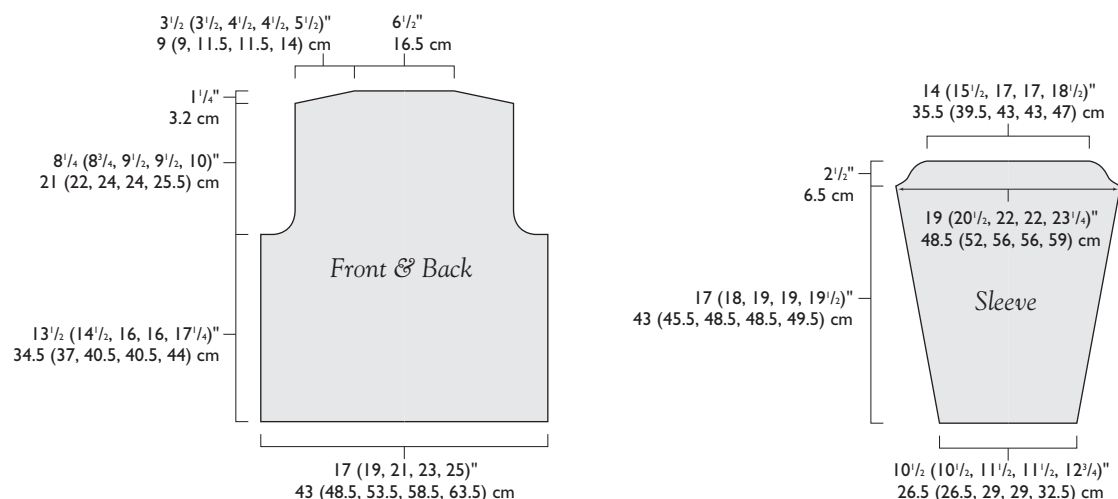



Waving Rib

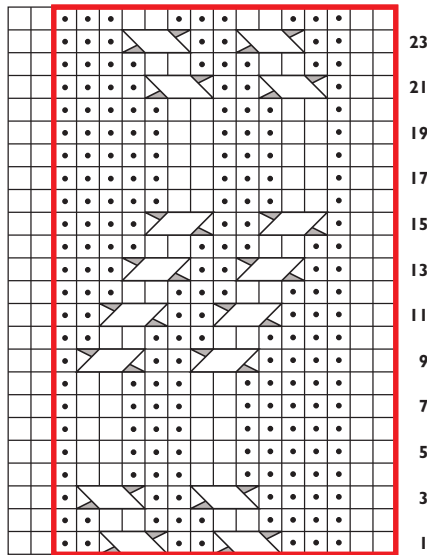

□ k on RS; p on WS

◦ p on RS; k on WS

2/1 RPC: sl 1 st onto cn and hold in back, k2, p1 from cn

2/1 LPC: sl 2 sts onto cn and hold in front, p1, k2 from cn

pattern repeat

of needle every RS row 7 times—68 (76, 83, 83, 90) sts rem. Work 1 row even. BO all sts in patt.

Finishing

Weave in loose ends. With yarn threaded on a tapestry needle, sew shoulder seams. Beg at one shoulder edge, place 41 sts each for front and back on cir

needle—82 sts total. Join yarn and work in rib patt as established, working p2tog once at each shoulder seam on first rnd to maintain k2, p3 rib—80 sts rem. Cont in rib for 1" (2.5 cm). BO all sts *loosely* in patt. Sew sleeves into armholes, easing to fit. Sew side and sleeve seams. ∞

KAREN BAUMER knits and listens to Bob Dylan while commuting to her job as a linguist in San Francisco.

Morning Star

- Pattern \$6.00

www.treeoflifedesigns.net
treeoflife@metrocast.net

Tree of Life Designs

Donna Kay
163 Green Hill Rd.
Barrington, NH 03825

"DESIGNS IN THE FOLK TRADITION"

603-332-0291

WWW.PRAIRIEFIBERS.COM

LARGEST SELECTION OF:

- NATURAL DYES & NATURAL DYE EXTRACTS
- PIGMENTS, OXIDES, OCHERS & INKS
- AUXILIARIES & MORDANTS
- BOOKS

EXQUISITE HAND-DYED:

- SILK, COTTON, & WOOL FABRICS
- YARNS: PLAIN AND FANCY
- SILK RIBBONS & THREADS
- FIBERS: SILK, WOOL & FLAX

SECURE ON-LINE ORDERING
515-232-0912

DC's source for knitting & crochet yarns, books, tools, and community.

NOW TWO LOCATIONS:

- CAPITOL HILL
731 8th St. SE, Washington, DC
- GEORGETOWN
1071 Wisconsin Ave. NW, Washington, DC

StitchDC

www.stitchdc.com

Tahki - Stacy Charles - Anny Blatt - Jamieson's - Under Mountain

SEAPORT YARN

135 William St., 5th FLOOR
NY, NY 10038
(Between Fulton and John Streets)
212-608-3100 | 1-800-347-2662
seaportyarn@aol.com
www.seaportyarn.com

Scheepjes - Karabella - Fiesta Yarns - Ellen Cooper - Colinette - Manos

SEEING IS BELIEVING

"Wool You Come And See Us?"

Largest Selection of Needles, Hand-dyes, Kits, and Books in N.Y.C.

10% OFF WHEN YOU MENTION THIS AD

SPECIAL SALE ON: Southwest Trading Company
Soy Silk (Special Hand-Dyes Only At Our Store)

- 50% Soy and 50% Wool in 3 weights (Bella, Sophia, Giana) Hand-Dyed
- Bamboo (16 Colors) - \$13.50
- Melody in 10 Colors - \$14.00
- Illusion in 4 colors: \$16.00
- Infinity: \$14.00
- BRAND NEW: OPTIMUM DK - \$13.00, WORSTED - \$26.00

Lost Points Shawl in all colors
PLUS KIT YOUR OWN: \$30.00-\$40.00

WE SHIP IN THE USA, CANADA, AND ENGLAND

LOOK FOR US AT STITCHES

Dancing Fiber - Garnstudio - Soy Silk - Lanax Stop
Great Adirondack - Cherry Tree Hill - Wool In The Woods - Philosopher's Wool
Plymouth - Brown Sheep - Mission Falls - Wool Pak - Bouton d'Or

Save Your Back Issues of

**INTERWEAVE
KNITS**



Organize and protect your **Interweave Knits** collection. These handsome storage boxes are covered in a rich maroon leather-like material. A two-color decorative **Interweave Knits** label is included for personalizing. **They also make a great gift.**

One - \$15.00 Three - \$40.00 Six - \$80.00

*******Order form*******

Please send me _____slipcases.

My check for \$ _____ is enclosed.

Add \$3.50 per slipcase for P & H. USA orders only.
PA residents add 6% sales tax.

Make checks payable to **TNC Enterprises, Dept
IWK, PO Box 2475, Warminster, PA 18974**

Name _____

Address _____

(No PO Boxes Please)

City, State, Zip _____

Credit Card: AmEx, Visa, MC

Send: name, number, exp. date

To Order Online:

www.tncenterprises.net/iwk.html

yarns by design

Have a Fall Fiber Fling!

come to

Fall Midwest Masters Seminar

October 1- 2, 2005

Join **Lucy Neatby, Chris Bylsma** and
Cat Bordhi for a weekend of fun and
creative exploration!

Shop whenever the urge hits you

at

www.yarnsbydesign.com

Secure online ordering 24/7!

*NEW! Blue Sky Cotton Yarn

*Manos del Uruguay Cotton Stria

*Lucy Neatby's Celestial Merino

*Hundreds of patterns and books from

your favorite designers

*Needles and more...

Quick turnaround for in-stock items!

123 W. Wisconsin Ave. ❖ Neenah, WI 54956

Mon. - Sat. 10 a.m. - 5 p.m. ❖ 1-888-559-2767

Quality

It's the fabric of our business.

Shop the largest selection of natural fiber yarns. Over 500 colors, textures & sizes. Unique kits, special order yarns & more!

You'll love our quick delivery & friendly service!

Register online for free patterns & weekly specials.

Catalog & Yarn Samples - \$5.00

COTTON CLOUDS
25 Years
OF QUALITY

1-800-322-7888
www.cottonclouds.com



**Hand Jive
Knits**



Original designs
featuring
Nature's Palette™
naturally-dyed yarns
and fibers

www.handjiveknits.com
wholesale inquiries welcome



**Crocheted Felt
Ballet Slippers**

from *Fiber Trends*

Kit Special

\$19.95 + s&h

pattern & 10 ply Woolpak
in berry, red, navy, med blue,
olive, or brown.



order line 1.800.987.6354

2818 NE 55th St. Seattle, WA 98105
(206) 525-1726 • www.acornstreet.com

• Artyarns • Blue Sky Alpaca • Cascade • Colinette • Crystal Palace

• Regia • Rowan • And More!



Knit Happens
Nirvana for Knitters

www.knithappens.net

127A N. Washington St., Old Town Alexandria, VA 22314
703-836-0039

On Line • Mission Falls • Manos • Lorna's Laces • Katia • Karabella • Koigu • Jaeger



Debbie Bliss • Gedifra



PAM ALLEN

SHOULDER SHRUGS

For the summer staff project, we chose to knit shrugs—those versatile, comfortable alternatives to sweaters and shawls. Simple to make and fun to wear, shrugs are the perfect summer accessory.

You'll find complete instructions for all six shrugs on our website at www.interweaveknits.com. Or send a long self-addressed stamped envelope to Shrugs, 201 E. Fourth St., Loveland, CO 80537.



MEEMA SPADOLA



SUSAN STERNLIEB



MARY JANE MUCKLESTONE



SANDI WISEHEART

Pam Allen, Editor-in-Chief

I wanted to make a feminine piece that wasn't over-the-top girlie. A rayon-blend yarn with a beautiful drape, a short ruffle, and expandable ribs seemed like a good combination for a simple piece that would work well with a dress or jeans.

Yarn: Patons Katrina.

Meema Spadola, Contributing Editor

For this shrug, I wanted to use an open-stitch pattern to show off the luscious color and sheen of the silk-merino yarn. I settled on a drop-stitch pattern with an organic feel that reminds me of ripples in tree bark or even-flowing water. Because the shrug is worked side to side, the pattern appears vertical on the sleeves and horizontal across the back. To simplify the task of working increased stitches into the asymmetrical pattern, I let the ribs become the border.

Yarn: Alchemy Synochronicity.

Susan Sternlieb, Editorial Assistant

I chose simple stockinette stitch to show off the soft colors and ripply texture of the ribbon yarn. The slightly flared three-quarter-length sleeves are complemented by a garter-stitch edging.

Yarn: Colinette Giotto (distributed by Unique Kolours).

Mary Jane Mucklestone, Photostylist

For this shrug, I took inspiration from the tiny bodices worn during the Regency period by the Empress Josephine and seen in Kate Greenaway drawings and the new movie *Vanity Fair*. I started at the cuffs and knitted two three-quarter-length sleeves (each with a single delicate cable) that increase in width to form a small elegant bodice, then grafted them together with Kitchener stitch. I used a favorite brooch from my grandmother's jewelry box to fasten the shrug at the bust.

Yarn: South West Trading Company Oasis.

Sandi Wiseheart, Managing Editor

Luscious and feminine, this mohair and silk yarn begged to become something special. I chose a traditional lace pattern simple enough for beginners, and knitted it on big needles. The beads bring out the luster of the silk, and a knitted flower, also embellished with beads, lends a final touch. The back is knitted first, and stitches are picked up on each side to knit the sleeves in the round from shoulder to cuff. Then stitches are picked up around the entire inside edge and knitted to form a ribbed border.

Yarn: Naturally Kid et Soie (distributed by S.R. Kertzer).

Ann Budd, Senior Editor

I don't normally gravitate toward novelty yarn, but the odd texture in this yarn intrigued me. To keep the focus on the texture, I purposely made the stitch pattern and shaping simple—I knitted a rectangle in stockinette stitch. But I just couldn't stop myself from working the short ends (what would become the "cuffs") on progressively larger needles to give them a little flair.

Yarn: Gerofil Twingo (distributed by Plassard).



ANN BUDD

SHUTTLES,

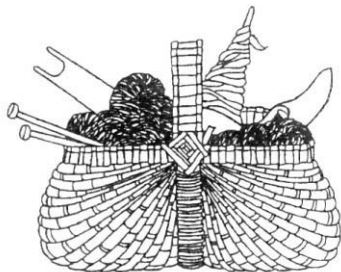

SPINDLES & SKEINS

Weaving • Basketry • Spinning
Knitting • Classes • Equipment

635 S. Broadway, Unit E
Boulder, Colorado 80305
(in the Table Mesa Center)

(303) 494-1071 • (800) 283-4163

Visit our web site:
www.shuttlesspindlesandskeins.com

Mon 12-6 pm • Tues-Sat 10-6 pm

Closed Sundays

Unique • Chic • Fabulous Yarns

by Noro, Great Adirondack, Koigu, Colinette, Mountain Colors and others

- Great classes, books, needles and more!

Internet supplier @
www.knitandstitch.com

Order By Phone Toll-Free:
1-866-5NEEDLE

4706 Bethesda Ave. • Bethesda, MD 20814

Anny Blatt ~ Aurora ~ Vittadini ~ Katia ~ Elite ~ Dale ~ Jaeger ~ Falkenberg

Aylin's Woolgatherer
1-800-775-wool

Great selection of exquisite yarns ~ Hundreds of buttons
Area's largest collection of pattern books
Rosewood, Addi and Clover needles
Personal Service ~ Expert Finishing ~ Instructions
Look for our special events on our website: <http://www.aylins-wool.com>
7245 Arlington Blvd. Falls Church, VA 22042 (703) 573-1900
Email us: aylin@aylins-wool.com

Tahki ~ Lang ~ Trendsetter ~ Rowan ~ Swedish Yarn ~ Fiesta Yarns ~ Jo Sharp

It's our *THIRD ANNUAL*
**FIBER ARTS
Conference**

"Creative Strands 2005"

July 6 - 10, at
University of Pittsburgh
in Johnstown, PA

Weaving
Spinning
Dyeing
Felt Making
Tapestry
Knitting
and Related Arts

Presented by Augusta Marketing
For Registration Materials
call 570-473-8278
email info@creativestrands.com
or visit www.creativestrands.com

Misti Alpaca

- 100% Baby Alpaca Yarn Imported from Peru
- Sport, Lace, Worsted, and Chunky Weights
- 87 Exciting Colors Available
- Luxurious

Misti International, Inc.
549 Dorset Ave • Glen Ellyn, IL
1 • 888 • 776 • YARN
(9276)
Fax: 888 • 896 • YARN

E-mail • info@MistiAlpaca.com

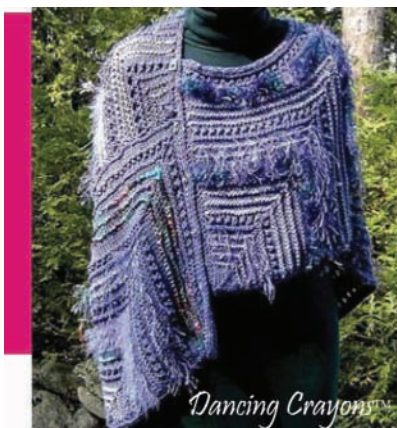

*Hand knit artwear.
Created by you.*

View the full line of knitting patterns
and find a retail source near you at
www.chrisbylsmadesigns.com

Retailers: For wholesale inquiries, call
608-233-3967 or email chris@chrisknit.com

Chris Bylsma Designs
734 Miami Pass • Madison, WI 53711

GOT GAUGE?

If Not, You Won't Have Fit, Either

Sandi Wiseheart

Regardless of how lucky you've been in the past, and no matter how tedious it is to put off the real knitting, if you want to ensure that a project will work up to the measurements specified in the pattern, you must work a sample of knitting and compare the gauge you get with the gauge specified. Gauge is simply the number of stitches and rows in a given number of inches of knitting. If your gauge is fewer stitches per inch than the pattern calls for, the finished garment will be too large; if your gauge is more stitches per inch, the finished garment will be too small. Even a hair off can mean that a final project is several inches smaller or larger than you intended.

To measure gauge: Cast on 30 to 40 stitches, or an equivalent multiple of the pattern stitch given, using the recommended needle size. Work in the specified pattern stitch until the piece measures a little more than 4" (10 cm) from the cast-on edge. (In

general, knitting patterns measure gauge over 4 inches [10 cm].) Bind off the stitches loosely. Wash or block the swatch as you would the finished project. Lay the swatch on a flat surface. Place a ruler over the swatch and measure out 4" (10 cm) in width and length; then count the number of stitches and the number of rows (including fractions of stitches and rows—a half-stitch can make a big difference when multiplied by the finished width of the piece!) in the measured 4 inches. Repeat this process two or three times on different areas of the swatch to confirm your initial measurement. If you have more stitches and rows than called for in the instructions, your stitches are too small and you should try again with larger needles; if you have fewer stitches or rows, your stitches are too large and you should try again with smaller needles. Repeat the process until you get the gauge you're after. Remember that the most important thing is to match the gauge specified in the pattern. You can change needle size, substitute yarns, play around with stitch patterns to your heart's content—as long as your gauge matches the one specified in the pattern for your project, the dimensions of the finished project will match those of the pattern.

Note: Even the most carefully worked swatch can differ in gauge from a large piece of knitting. The cardinal rule is: The larger the swatch, the more accurate it is. Always check the measurements of a project after you've worked the first few inches to make sure the gauge of the project is consistent with the gauge of the swatch.

Tips for Making a Gauge Swatch

- Always work the gauge swatch with the needles you intend to use for the final project. Even needles in the same size, if made from different materials or by different companies, can yield different gauges.
- The gauge in most published patterns is measured after blocking, so be sure to block your swatch (using the same method you will use to block the finished garment) before measuring.
- Use the exact same techniques in a swatch as you will use in the project. For example, if you are working a Fair Isle pattern, and always float the yarns across the back of your work, be sure to float the yarns in the swatch.
- For lace, cable, and color work patterns, try to work a gauge swatch that is at least two full repeats of the pattern both in width and in length. Doing so results in a more accurate measurement of the overall gauge: You will see beforehand how the pattern repeats fit together and whether one part of the pattern draws in (or spreads out) more than the rest.
- To measure gauge in the round: Cast on 30 to 40 stitches and divide them evenly between 3 or 4 needles. Join and proceed as for a flat gauge swatch, but work in rounds rather than rows.

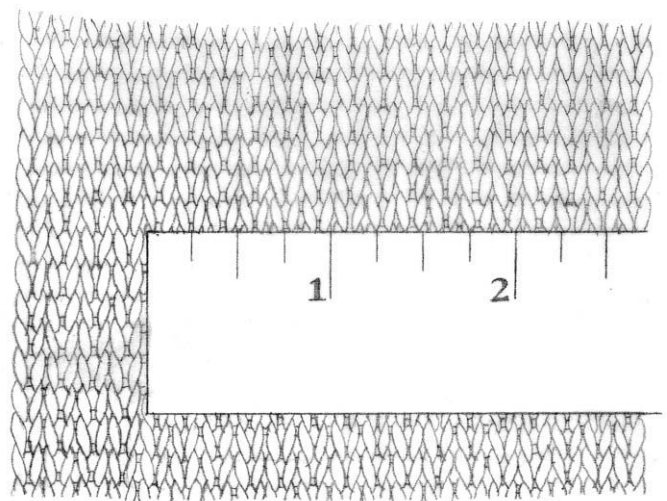

This swatch has a gauge of 6 sts per inch.

SANDI WISEHEART is the managing editor of *Interweave Knits*.

GO WITH THE FLOW SOCKS

design by EVELYN A. CLARK

A PAIR OF WARM, PRETTY SOCKS is one of life's little pleasures. In a soft, luxurious merino, this pair would make a great present for oneself. The short cuff is worked in a lace ladder pattern, and a simple combination of vertical stitch patterns runs from the cuff to the toe. The stitch patterns repeat every four rounds, so they're easy to memorize and simple to knit.

Finished Size About 6" (15 cm) foot circumference, relaxed, and 9½" (24 cm) long from back of heel to tip of toe. To fit woman's U.S. shoe sizes 7 to 8.

Yarn Cherry Tree Hill Supersock Solids (100% merino; 370 yd [338 m]/4 oz): Nantucket red, 1 skein.

Needles Size 1 (2.25 mm): set of 4 double-pointed (dnp). Adjust needle size if necessary to obtain the correct gauge.

Notions Marker (m); tapestry needle.

Gauge 36 sts and 52 rnds = 4" (10 cm) in St st, worked in the rnd.

Note

Because this lace pattern has a lot of stretch, it is important to try on the sock or to stretch it widthwise when measuring the length.

Leg

Loosely CO 60 sts. Divide sts on 3 dnp so that there are 18 sts each on Needle 1 and Needle 2, and 24 sts on Needle 3. Place marker (pm) and join for working in the rnd, being careful not to twist sts. Purl 1 rnd. Work Rnds 1–2 of Cuff chart 5 times, then purl 1 rnd—piece should measure about 1" (2.5 cm) from beg. Work Rnds 1–4 of Leg chart 20 times—piece should measure about 7¼" (18.5 cm) from CO.

Heel

Heel flap: Turn work and p28 sts onto 1 dnp—28 heel sts. Hold rem 32 sts on 2 dnp to be worked later for instep. Work 28 heel sts back and forth in rows as foll:

Row 1: (RS) *Sl 1 pwise, k1; rep from *.

Row 2: Sl 1 pwise, purl to end.

Rep Rows 1 and 2 a total of 18 times, then work Row 1 once more—heel flap should measure about 2" (5 cm) from beg; 18 slipped selvedge sts along each edge of heel flap.

Turn heel: Cont in short rows (see Glossary, page 105) as foll:

Row 1: (WS) Sl 1, p14, p2tog, p1, turn.

Row 2: (RS) Sl 1, k3, ssk, k1, turn.

Row 3: Sl 1, purl to 1 st before gap formed on previous row, p2tog, p1, turn.

Row 4: Sl 1, knit to 1 st before gap formed on previous row, ssk, k1, turn.

Rep Rows 3 and 4 until all heel sts have been worked—16 heel sts rem.

Gussets: Cont in rnds as foll:

Rnd 1: With needle holding heel sts (Needle 1), pick up and knit 19 sts along left edge of heel flap; with Needle 2, work 32 instep sts according to Rnd 1 of Instep chart; with Needle 3, pick up and knit 19 sts along right edge of heel flap, then knit the first 8 heel sts from Needle 1—86 sts total; 27 sts each on Needle 1 and Needle 3, 32 instep sts on Needle 2. Rnd begins at center of heel.

Rnd 2: Needle 1: k8, [k1 through back loop (tbl)] 19 times; Needle 2: cont in instep patt as established; Needle 3: [k1tbl] 19 times, k8.

Rnd 3: (dec rnd) Needle 1: knit to last 2 sts, k2tog; Needle 2: cont in instep patt as established; Needle 3: ssk, knit to end—84 sts rem.

Rnd 4: Needle 1: knit; Needle 2: work instep patt as established; Needle 3: knit.

Rep Rnds 3 and 4 until 60 sts rem—14 sts each on Needle 1 and Needle 3; 32 instep sts on Needle 2.

Foot

Cont even, working instep sts in patt as established and other sts in St st until foot measures 8" (20.5 cm) from back of heel, or about 1½" (3.8 cm) less than desired total length (measured with sock on foot or with lace pattern stretched horizontally; see Note), ending with an even-numbered rnd of instep patt.

Toe

Knit 1 rnd, redistributing sts as foll: Needle 1: k14, k1 from Needle 2; Needle 2: k30; Needle 3: knit last st from Needle 2, then k14—15 sts each on Needle 1 and Needle 3; 30 sts on Needle 2.

Rnd 1: (dec rnd) Needle 1: knit to last 3 sts, k2tog, k1; Needle 2: k1, ssk, knit to last 3 sts, k2tog, k1; Needle 3: k1, ssk, knit to end—4 sts dec'd.

Rnd 2: Knit.

Rep Rnds 1 and 2 until 32 sts rem, then work Rnd 1 *only* until 12 sts rem.

Finishing

Knit 3 sts from Needle 1 onto Needle 3—6 sts each on 2 needles.

Cuff

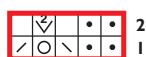

Leg

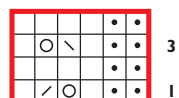

Instep

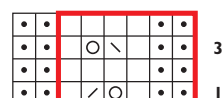

k on RS; p on WS



yo



ssk



pattern repeat



p on RS; k on WS



k2tog



(k1, p1) in yo



Cut yarn, leaving a 12" (30.5-cm) tail. With tail threaded on a tapestry needle and using the Kitchener st (see Glossary, page 105), graft rem sts tog. Weave in loose ends. Block lightly. ∞

EVELYN A. CLARK lives in Seattle, Washington, where she enjoys incorporating lace into all types of knitting projects.

BABY gifts

Indulge your favorite newborn, or your favorite new parents, with a handknitted gift that will be cherished for years.



All photos this section: Joe Coca

BABY KIMONO

Kristin Spurkland

Worked in garter stitch in a single piece, this baby jacket couldn't be easier to knit. And the finishing is a breeze, too—the shoulders are joined with a three-needle bind-off and the only seams to sew are along the sleeves. The off-center front opening is fastened with a delicate ribbon tie.

Finished Size 20 (22, 24)" (51 [56, 61] cm) chest circumference, fastened. To fit newborn (6 months, 12 months). Sweater shown measures 20" (51 cm).

Yarn Rowan Wool Cotton (50% merino, 50% cotton; 124 yd [113 m]/50 g): #900 antique, 3 (3, 4) balls. Yarn distributed by Westminster Fibers.

Needles Size 3 (3.25 mm): 24" (60-cm) circular (cir) and one extra needle for BO. Adjust needle size if necessary to obtain the correct gauge.

Notions Safety pin; stitch holders; tapestry needle; ¼ yard (¼ m) ⅜"- (1-cm) wide ribbon.

Gauge 24 sts and 48 rows = 4" (10 cm) in garter st.

Note

For tidy and attractive edges, slip the first stitch of all rows knitwise with yarn in back.

Body

With cir needle, CO 120 (132, 144) sts. Do not join. Slipping the first st of every row (see Note), work garter st (knit every row) until piece measures 2" (5 cm) from beg. Decide which side will be WS (both sides will look the same) and attach a safety pin to that side. Cont in garter st until piece measures 6½ (7, 7½)" (16.5 [18, 19] cm) from beg, ending with a WS row. **Divide for fronts and back:** (RS) K40 (44, 48) for right front, place next 60 (66, 72) sts on holder to work later for back, place rem 20 (22, 24) sts on another holder to work later for left front. Turn work. **Right front:** Using the cable method (see Glossary, page 104), CO 20 (22, 24) sts at beg of row—60 (66, 72) sts. Cont in garter st until piece measures 2¼ (2½, 2½)" (5.5 [5.5, 6.5] cm) from dividing row, ending with a WS row. **Shape neck:** (RS) BO 20 (22, 24) sts, knit to end—40 (44, 48) sts rem. Cont even in garter st until piece measures 9¾ (10½, 11¼)" (25 [26.5, 28.5] cm) from beg, ending with a WS row. Cut yarn and place sts on holder. **Back:** Place 60 (66, 72) held back sts on cir needle. With RS facing, rejoin yarn and use cable method to CO 20 (22, 24) sts at beg of next 2 rows—100 (110, 120) sts. Cont in garter st until piece measures 9¾ (10½, 11¼)" (25 [26.5, 28.5] cm) from beg, ending with a RS row. **Shape neck:** K40 (44, 48) sts and place on holder, BO center 20 (22, 24) sts, knit to end—40 (44, 48) sts rem. Place rem sts on holder.

Left front: Place 20 (22, 24) held left front sts onto cir needle. With RS facing, rejoin

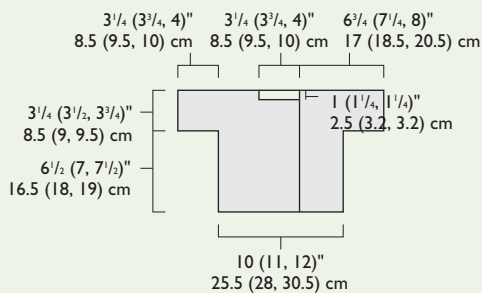

yarn and use cable method to CO 20 (22, 24) sts at beg of row—40 (44, 48) sts. Cont in garter st until piece measures 9¾ (10½, 11¼)" (25 [26.5, 28.5] cm), ending with a WS row. Place sts on holder.

Finishing

With RS together and using the three-needle method (see Glossary, page 106), BO shoulder stitches tog. With yarn threaded on a tapestry needle, sew sleeve seams. Weave in loose ends. Block to measurements. **Ribbon tie:** Cut ribbon in half. Thread one length on tapestry needle and, working from the RS, insert tapestry needle under a garter ridge about 1¼" (3.2 cm) down from neck edge, and ½" (1.3 cm) in from front edge on right front. Bring needle back out to the front of the work, and remove needle, leaving a 2" (5-cm) tail where the needle exited. Tie the two ends of the ribbon into an overhand knot to secure in place. Trim ribbon ends. Rep for second length of ribbon, positioning it on left front, opposite first ribbon. ∞

KRISTIN SPURKLAND lives in Portland, Oregon, and is the author of *Knits from the Heart* (Martingale, 2004).



BETTER-THAN-BOOTIES BABY SOCKS

Ann Budd

Not keen on baby booties? Try baby socks. Ann Budd has designed five adorable pairs of tiny socks to make precious little feet even more precious. All feature Priscilla Gibson-Roberts's short-row heel and toe (Fall 2000 *Interweave Knits*, page 76) and decorative zigzag bind-off. Worked in washable wool, these socks are easy to care for—an important feature in babywear. Instructions for three of the socks are given here. Visit www.interweaveknits.com for instructions for two more.

Finished Size About 4¾" (12 cm) foot circumference and 3½" (9 cm) long from back of heel to tip of toe.

Yarn Lorna's Laces Shepherd Sock (80% superwash wool, 20% nylon; 215 yd [196 m]/50 g): 1 skein will make 3 pairs of socks. Shown in #21NS powder blue, # 44NS old rose, and #15NS chino.

Needles Size 0 (2 mm): set of 4 or 5 double-pointed (dpn). Adjust needle size if necessary to obtain the correct gauge.

Notions Markers (m); cable needle (cn); tapestry needle.

Gauge 18 sts and 26 rnds = 2" (5 cm) in St st worked in the rnd.



Stitch Guide

Ssp: Slip 2 sts individually kwise, return these 2 sts to left needle, and purl them tog through their back loops.

Sssp: Slip 3 sts individually kwise, return these 3 sts to left needle, and purl them tog through their back loops.

Ruffle Rib Socks (shown in blue)

Leg: CO 88 sts. Distribute sts evenly on 3 or 4 dpn, place m (pm), and join for working in the rnd, being careful not to twist sts. Work ruffle as foll:

Rnds 1, 2, and 3: *K2, p2; rep from *.

Rnd 4: *K2, p2tog; rep from *—66 sts rem.

Rnds 5 and 6: *K2, p1; rep from *.

Rnd 7: *K1, ssk; rep from *—44 sts rem.

Knit 1 rnd even. *Eyelet rnd:* *Yo, k2tog; rep from *. *Next rnd:* *P1, k1; rep from *. Rep the last rnd 15 more times, ending 11 sts before end-of-rnd marker on last rnd. **Heel:** Arrange sts so that the next 22 sts are on one needle for the heel, removing marker as you go (working yarn is at the right edge of these sts)—22 sts total for heel; divide rem 22 sts between 2 needles to be worked later for instep). Work 22 heel sts in short rows as foll:

Row 1: (RS) K21, turn (1 st unworked on left needle).

Row 2: Yo backwards (see Toe and Heel Construction box at lower right), p20, turn (1 st unworked).

Row 3: Yo as usual, knit to paired sts made by yo of previous row (the yo will form a loop out of the side of the adjacent st), leaving 3 sts on left needle (i.e., do not work the pair), turn.

Row 4: Yo backwards, purl to paired sts made by the yo of the previous row, turn.

Rep the last 2 rows until there are 11 total sts between yos (9 unpaired sts between yos), ending with a WS row. Turn so RS is facing. Form the heel cup as foll:

Row 1: (RS) Yo as usual, knit to the paired st made by yo of previous row, k1, (the first st of the pair), correct the mount of the yo (so that the leading edge is on the front of the needle), k2tog (the yo with the first st of the next pair, leaving a yo as the first st on the left needle), turn.

Row 2: (WS) Yo backwards, purl to paired st made by yo of previous row, purl the first st of the pair, ssp (the yo with the first st of the next pair, leaving a yo as the first st on the left needle; see Stitch Guide), turn.

Row 3: Yo, knit to the paired st made by yo of previous row, knit the first st of the pair (the next 2 loops will be yos), correct the mount of each of these yos, k3tog (2 yos with the first st of the next pair), turn.

Row 4: Yo backwards, purl to next yo (the next 2 loops are yos), sssp (2 yos with the first st of the next pair; see Stitch Guide), turn.

Row 5: Yo, knit to next yo (the next 2 loops will be yos), correct the mount of each of these yos, k3tog (2 yos with the first st of the next pair), turn.

Rep the last 2 rows until all yos of heel have been worked, ending with Row 4. The last turn will bring RS facing—22 sts + 1 yo. *Joining rnd:* Yo, knit to yo at end of needle, place this yo on next needle (first instep needle), k2tog (the yo plus first st of next needle), work to last instep st, place yo at beg of next (heel) needle onto instep needle and work these 2 sts as ssk (last st of rnd plus yo)—44 sts. Rnd begins at beg of sole sts.

Foot: Work even in St st for 16 rnds.

Toe: Rearrange sts if necessary so that 22 bottom-of-foot (sole) sts are on one dpn. Work toe with short-rows as for heel. After making the last turn, the toe is joined to the top of the foot with a zigzag bind-off: Place 22 instep sts on 1 dpn and 22 sole sts on another dpn. Holding the 2 needles tog, sl 1 from front needle, p1 from back needle, pass slipped st over purled st, *k1 from front needle, pass slipped st over, p1 from back needle, pass first st over; rep from * until 1 st rem on needle, working last st tog with its accompanying yo. Fasten off.

Finishing

Weave in loose ends. Block lightly if desired.

Braided Cable Socks (shown in pink)

Leg: CO 45 sts. Distribute sts evenly on 3 or 4 dpn, place marker (pm), and join for working in the rnd, being careful not to twist sts. *Set-up rnd:* [K1, p1] 6 times, k1, work Rnd 1 of Braided Cable chart over next 18 sts, [k1, p1] 7 times. Cont in this manner, working center 18 sts as charted and rem sts in k1, p1 rib until Rnds 1–8 of chart have been worked 3 times (24 rnds). Work 4 more rnds, working ribbed sts in St st, and ending with Rnd 4 of chart. **Heel:** Working 22 heel sts in St st, work short-row heel as for Ruffle Rib socks. **Foot:** Cont working cable patt on center 18 sts and rem sts in St st for a total of 2 patt repeats (16 rnds), then work Rnds 1–4 again—20 rnds total. Knit all sts for 1 rnd, dec 1 st at center of cable panel—44 sts rem. **Toe:** Work as for Ruffle Rib socks.

Toe and Heel Construction

The toe and heel are constructed with short rows that produce an hourglass shape. Each short row begins with a yarnover that is instrumental in preventing gaps. When the knit side is facing, work the yarnover in the usual manner, bringing yarn forward under needle then over the top to the back. When the purl side is facing, bring yarn to the back under needle, then over the top to the front as illustrated here. This forms a “backward” yarnover—the leading side of the loop is on the back of the needle.



Hugs & Kisses Socks (shown in tan)

Leg: CO 45 sts. Distribute sts evenly on 3 or 4 dpn, place marker (pm), and join for working in the rnd, being careful not to twist sts. *Set-up rnd:* [K1, p1] 8 times, k1, work Rnd 1 of Hugs & Kisses chart over next 12 sts, [k1, p1] 8 times. Cont in this manner, working center 12 sts as charted and rem sts in k1, p1 rib for 23 more rnds, ending with Rnd 8 of patt—24 rnds total. Work 1 rnd (Rnd 9 of chart), changing rib sts to St st. **Heel:** Working 22 heel sts in St st, work short-row heel as for Ruffle Rib socks. **Foot:** Beg with Rnd 10 of chart, cont working cable patt on center 12 sts and rem sts in St st until Rnds 1–16 have been worked a total of 3 times from beg of leg, ending with Rnd 16. Knit all sts for 1 rnd, dec 1 st at center of cable panel—44 sts rem. **Toe:** Work as for Ruffle Rib socks. ∞

ANN BUDD is the senior editor of *Interweave Knits* magazine.

Hugs & Kisses

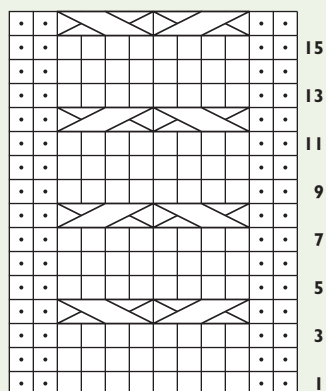

Braided Cable

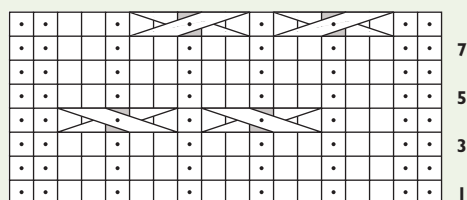

□ k on RS; p on WS

• p on RS; k on WS

2/2 RC: sl 2 sts onto cn and hold in back, k2, k2 from cn

2/2 LC: sl 2 sts onto cn and hold in front, k2, k2 from cn

2/1/2 RC: sl 3 sts onto cn and hold in back, k2, slip last st on cn (purl st) to left needle and purl it, k2 from cn

2/1/2 LC: sl 3 sts onto cn and hold in front, k2, slip last st on cn (purl st) to left needle and purl it, k2 from cn



HEART SACHET

Vicki Sever

Just the right size to tuck into a drawer or suitcase, Vicki Sever's heart sachet is worked in mitered squares that build one upon the other. Work fourteen nearly identical squares, stuff the piece with your favorite dried flowers or potpourri (Vicki used lavender), sew the top closed, and you're done. Yarn: Koigu Premium Merino. Visit our website at www.interweaveknits.com for instructions (or send a long SASE to Heart Sachet, 201 E. Fourth St., Loveland, CO 80537).

ITTY BITTY BEARS

Evelyn A. Clark

Teddy bears are ageless symbols of comfort and love, and these tiny bears knit up so quickly, you can create an entire family in an evening. They can decorate a backpack for the first day of school, trim a holiday tree, or add whimsy to a birthday gift. Or, tucked into the pocket or purse of a loved one, they can make any day a special occasion. The bears are worked from legs to head. The legs and arms are simple I-cord; the body is knitted in the round, with shapings for the neck, nose, and ears. A few embroidery stitches give the face personality.

Finished Size About 3¼" (8.5 cm) tall.

Yarn A few yards of sport-weight, worsted-weight, or bulky yarn.

We used Lorna's Laces Shepherd Socks.

Needles Set of 4 double-pointed (dpn) needles in size appropriate for yarn. We used size 0 (2 mm).

Notions Tapestry needle; waste yarn for stuffing head and body; contrasting yarn for embroidering eyes and nose.

Gauge Exact gauge is not important.

Bear

First leg: CO 4 sts. Work 4-st I-cord (see Glossary, page 105) for 6 rows. Cut off yarn, leaving an 8" (20.5-cm) tail. Leave sts on needle. **Second leg:** With another dpn, CO 4 sts. Work 4-st I-cord for 6 rows. Do not cut yarn. **Join legs for body:** Cont working I-cord on second leg sts, k3, k1f&b, k4 sts of first leg—9 sts



total. Distribute sts onto 3 dpn as foll: K2 with Needle 1, k5 with Needle 2, k2 with Needle 3. Join for working in the round. Knit 6 rnds. **Shape neck:** (8th rnd of body) K2tog, ssk, k1, k2tog, ssk—5 sts rem. **Next rnd:** [K1f&b] 2 times, k1, [k1f&b] 2 times—9 sts.

Shape nose:

Rnds 1 and 3: Knit.

Rnd 2: K4, ([k1f&b] 2 times, k1) all in same st, k4—13 sts.

Rnd 4: K4, sl 3 sts tog kwise, k2tog, pass 3 slipped sts over k2tog st (p3sso), k4—9 sts rem.

Rnds 5 and 6: Knit.

Shape ears: K2, *([k1f&b] 2 times) all in same st, turn work. P4, turn. [Sl 1 kwise] 4 times, return slipped sts to left needle, and k4tog through back loop (tbl)*, k3, rep from * to *, k2—9 sts rem. Break yarn, leaving an 8" (20.5-cm) tail. Thread tail through rem sts but do not tighten. **Arms:** (make 2) Work as first leg. Break yarn, leaving an 8" (20.5-cm) tail. Thread tail through rem sts and pull tight. Set aside.

Finishing

Stuff head with a small amount of waste yarn, pushing out nose to shape it as you do so. Gather top sts tightly to close top of head, and fasten off. Stuff body (through opening between legs) with more waste yarn. Use yarn tail from first leg to sew opening closed. With yarn tails, sew arms to sides below neck. Weave in yarn ends. With contrasting yarn, embroider a few stitches for eyes and nose. ∞

EVELYN A. CLARK lives in Seattle, Washington, where she enjoys all kinds of knitting.

Cherry Tree Hill

Supersock comes in solids as well as our 28 colorways. See Go With The Flow Socks in Nantucket Red on page 96.

Call or visit our website for a retailer near you.

www.cherry yarn.com
1-802-525-3311

the mannings Handweaving School & Supply Center

1132 Green Ridge Rd
PO Box 687
East Berlin, PA 17316
717-624-2223
ORDERS - 1-800-233-7166

We stock what every knitter needs: Knitting Books (189 titles), patterns from Ann Norling, Fiber Trends, Woolen collectibles, etc., yarns from Brown Sheep, JCA, Henry's Attic, Renaissance, Tahki, Plymouth, Skacel, etc., knitting needles, NEW wooden cable needles, and a large selection of the popular sock yarns. \$2.50 FOR CATALOG AND YARN STYLE CARD

Stitch Diva Studios | Modern Knit & Crochet Patterns



www.stitchdiva.com to purchase online or find a retailer near you



OAT COUTURE
natural knitting 

Available at fine needlework shops.
For a shop near you visit
www.oatcouture.com

Retailers, for wholesale information
contact Bryson Distributing 800-544-8992

Oat Couture
Box 967 Jacksonville, OR 97530

delightful patterns
for the
handknitter
and crocheter

Darling patterns for Baby
Timeless patterns for Adults
Playful patterns for Dolls
Unique Accessories
Tasteful Crochet
New Easy Knits



Basics and Beyond...

MAFA Conference 2005
National Conference Center
Lansdowne, Virginia, USA
July 12-17, 2005

Classes in: Weaving, Spinning, Felting and more,
including Beginning Spinning and Weaving Instruction

For further inquiries, please visit www.mafafiber.org

JEWELRY • TOTE BAGS • MUGS



individually handcrafted sterling silver bracelets \$38 each

www.abundantyarn.com 503-258-9276 (YARN)



Two Swans
Y A R N S

Fine yarns for traditional hand knitting

Featuring
Rowan Wool Cotton
Lorna's Laces Shepherd Sock
and, for Fair Isle knitting, Jamieson's Shetland Spindrift

Free shipping* anywhere in the US

Secure online ordering
www.twoswansyarns.com

*on orders of \$25 or more
Two Swans Yarns, LLC • Kent, WA • 1-888-830-8269

Visit Our Website!

11th Annual
**Finger Lakes
Fiber Arts
Festival**

September 17 & 18, 2005
Saturday 10-5
Sunday 10-4

Hemlock Fairgrounds, Hemlock NY

Over 50 fiber and yarn vendors.
Workshops and Demonstrations.
Skein and Garment Competition,
Sheep Dog Demonstrations.

Sponsored by the
Genesee Valley
Handspinners Guild
www.gvhg.org/fest.html
or contact
Debbie at 585-442-2989

MORE INNOVATIONS FOR STITCHING

ROSEWOOD KNITTING NEEDLES



Colonial Rosewood Knitting Needles are fashioned of the finest South Indian rosewood, a natural, renewable resource universally prized by cabinetmakers for its strength and durability. They are individually hand-crafted and highly polished to assure you a smooth and satisfying knitting experience. Available in 22 popular needle sizes: 14", 10", and double pointed 8".



Also ask for **JOHN JAMES** yarn and weaving needles at fine yarn and craft stores.

THE COLONIAL NEEDLE COMPANY
IMPORTERS OF FINE ENGLISH NEEDLES & THIMBLES

www.colonialneedle.com • 800-9-NEEDLE

ABBREVIATIONS

beg	beginning; begin; begins
bet	between
BO	bind off
CC	contrasting color
cm	centimeter(s)
cn	cable needle
CO	cast on
cont	continue(s); continuing
dec(s)	decrease(s); decreasing
dpn	double-pointed needle(s)
foll	following; follows
g	gram(s)
inc	increase(s); increasing
k	knit
k1f&b	knit into front and back of same st
k2tog	knit two stitches together
kwise	knitwise
LC	left cross
m(s)	marker(s)
MC	main color
mm	millimeter(s)
M1	make one (increase)
p	purl
p1f&b	purl into front and back of same st
p2tog	purl two stitches together
patt(s)	pattern(s)
pm	place marker
pssso	pass slipped stitch over
p2sso	pass two slipped stitches over
pwise	purlwise
RC	right cross
rem	remain(s); remaining
rep	repeat; repeating
rev St st	reverse stockinette stitch
rib	ribbing
rnd(s)	round(s)
RS	right side
rev sc	reverse single crochet
sc	single crochet
sk	skip
sl	slip
sl st	slip stitch (sl 1 st pwise unless otherwise indicated)
ssk	slip 1 kwise, slip 1 kwise, k2 sl sts tog tbl (decrease)
ssp	slip 1 kwise, slip 1 kwise, p2 sl sts tog tbl (decrease)
st(s)	stitch(es)
St st	stockinette stitch
tbl	through back loop
tog	together
WS	wrong side
wyb	with yarn in back
wyf	with yarn in front
yo	yarn over
*	repeat starting point (i.e., repeat from *)
**	repeat all instructions between asterisks
()	alternate measurements and/or instructions
[]	instructions that are to be worked as a group a specified number of times

Knitting Gauge

To check gauge, cast on 30 to 40 stitches using recommended needle size. Work in pattern stitch until piece measures at least 4" (10 cm) from cast-on edge. Remove swatch from needles or bind off loosely, and lay swatch on flat surface. Place a ruler over swatch and count number of stitches across and number of rows down (including fractions of stitches and rows) in 4" (10 cm). Repeat two or three times on different areas of swatch to confirm measurements. If you have more stitches and rows than called for in instructions, use larger needles; if you have fewer, use smaller needles. Repeat until gauge is correct.

Wraps Per Inch

If you substitute or spin a yarn for a project, you can compare the weight of the yarn to the project yarn by comparing wraps per inch (listed in Sources for Supplies on page 109). To do this, wrap your yarn around a ruler for one inch and count the number of wraps. If you have more wraps per inch, your yarn is too thin; fewer wraps per inch, your yarn is too thick.

Reading Charts

Unless otherwise indicated, read charts from the bottom up. On right-side rows, read charts from right to left. On wrong-side rows, read charts from left to right. When knitting in the round, read charts from right to left for all rows.

Continental (Long-Tail) Cast-On

Leaving a long tail (about ½" to 1" [1.3 to 2.5 cm] for each stitch to be cast on), make a slipknot and place on right needle. Place thumb and index finger of left hand between yarn ends so that working yarn is around index finger and tail end is around thumb. Secure ends with your other fingers and hold palm upwards, making a V of yarn (Figure 1). Bring needle up through loop on thumb (Figure 2), grab first strand around index finger with needle, and go back down through loop on thumb (Figure 3). Drop loop off thumb and, placing thumb back in V configuration, tighten resulting stitch on needle (Figure 4).

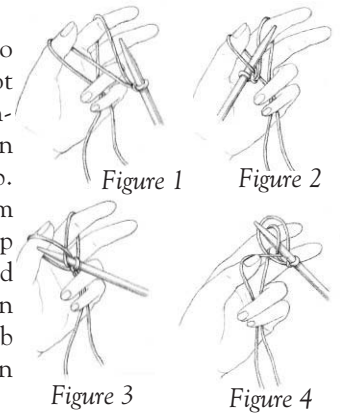

Crochet Chain (Provisional) Cast-On

With waste yarn and crochet hook, make a loose chain of about four stitches more than you need to cast on. With needle, working yarn, and beginning two stitches from end of chain, pick up and knit one stitch through the back loop of each crochet chain (Figure 1) for desired number of stitches. Work the piece as desired, and when you're ready to work in the opposite direction, pull out the crochet chain to expose live stitches (Figure 2).

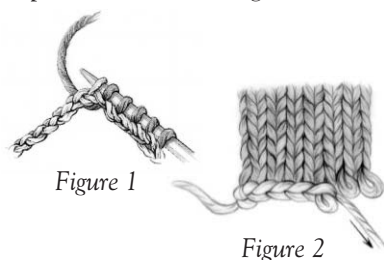

Cable Cast-On

Begin with a slipknot and one knitted cast-on stitch if there are no established stitches. Insert right needle between first two stitches on left needle (Figure 1). Wrap yarn as if to knit. Draw yarn through to complete stitch (Figure 2) and slip this new stitch to left needle as shown (Figure 3).

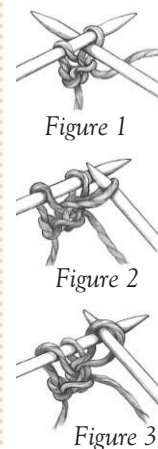

Backward Loop Cast-On

*Loop working yarn and place it on needle backward so that it doesn't unwind. Repeat from *.



Invisible (Provisional) Cast-On

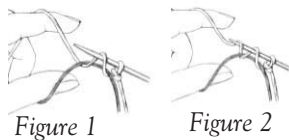

Figure 1

Figure 2

Place a loose slipknot on needle held in your right hand. Hold waste yarn next to slipknot and around left thumb; hold working yarn over left index finger. *Bring needle forward under waste yarn, over working yarn, grab a loop of working yarn (Figure 1), then bring needle to the front, over both yarns, and grab a second loop (Figure 2). Repeat from *. When you're ready to work in the opposite direction, pick out waste yarn to expose live stitches.

Knitted Cast-On

Place slipknot on left needle if there are no established stitches. *With right needle, knit into first stitch (or slipknot) on left needle (Figure 1) and place new stitch onto left needle (Figure 2). Repeat from *, always knitting into last stitch made.

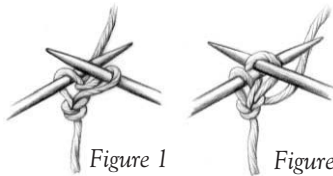

Figure 1

Figure 2

Raised (M1) Increases



Figure 1

Figure 2

With left needle tip, lift strand between needles from front to back (Figure 1). Knit lifted loop through the back (Figure 2).

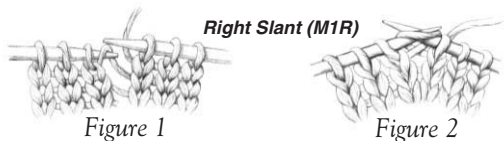

Figure 1

Figure 2

With left needle tip, lift strand between needles from back to front (Figure 1). Knit lifted loop through the front (Figure 2).

Purlwise (M1P)



Figure 1

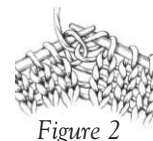

Figure 2

With left needle tip, lift strand between needles, from back to front (Figure 1). Purl lifted loop (Figure 2).

Ssk Decrease

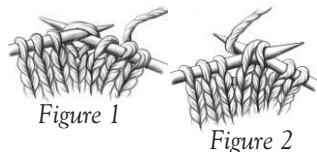

Figure 1

Figure 2

Slip two stitches knitwise one at a time (Figure 1). Insert point of left needle into front of two slipped stitches and knit them together through back loops with right needle (Figure 2).

Ssp Decrease

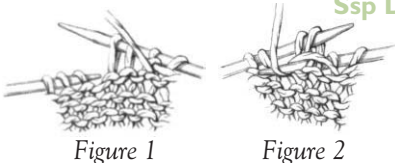

Figure 1

Figure 2

Holding yarn in front, slip two stitches knitwise one at a time onto right needle (Figure 1). Slip them back onto left needle and purl the two stitches together through back loops (Figure 2).

I-Cord



With double-pointed needle, cast on desired number of stitches. *Without turning the needle, slide the stitches to other end of the needle, pull the yarn around the back, and knit the stitches as usual; repeat from * for desired length.

Short Rows: Wrapping a Stitch



Figure 1



Figure 2

Work to turn point, slip next stitch purlwise to right needle. Bring yarn to front (Figure 1). Slip same stitch back to left needle (Figure 2). Turn work and bring yarn in position for next stitch, wrapping the stitch as you do so. *Note:* Hide wraps in a knit stitch when right side of piece is worked

in a knit stitch. Leave wrap if the purl stitch shows on right side. Hide wraps as follows: *Knit stitch:* On right side, work to just before wrapped stitch. Insert right needle from front, under the wrap from bottom up, and then into wrapped stitch as usual. Knit them together, making sure new stitch comes out under wrap. *Purl stitch:* On wrong side, work to just before wrapped stitch. Insert right needle from back, under wrap from bottom up, and put on left needle. Purl them together.

Kitchener Stitch for Stockinette Stitch

Step 1: Bring threaded needle through front stitch as if to purl and leave stitch on needle.
Step 2: Bring threaded needle through back stitch as if to knit and leave stitch on needle.

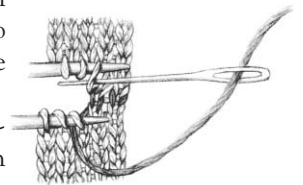

Step 3: Bring threaded needle through same front stitch as if to knit and slip this stitch off needle. Bring threaded needle through next front stitch as if to purl and leave stitch on needle.
Step 4: Bring threaded needle through first back stitch as if to purl (as illustrated), slip this stitch off, bring needle through next back stitch as if to knit, leave this stitch on needle.

Repeat Steps 3 and 4 until no stitches remain on needles.

Kitchener Stitch for Ribbing:

Divide the sts on each piece between two needles—the knit sts on one needle and the purl sts on the other. Graft the sets of knit sts tog as described for stockinette st above, then turn the work over so the purl sts appear as knit sts and do the same for them.

Mattress Stitch Seam

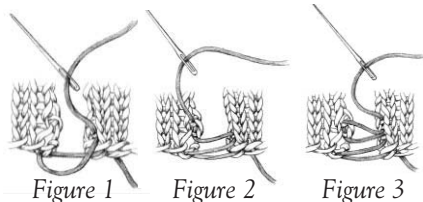

With RS of knitting facing, use threaded needle to pick up one bar between first two stitches on one piece (Figure 1), then corresponding bar plus

the bar above it on other piece (Figure 2). *Pick up next two bars on first piece, then next two bars on other (Figure 3). Repeat from * to end of seam, finishing by picking up last bar (or pair of bars) at the top of first piece.

Three-Needle Bind-Off

Place stitches to be joined onto two separate needles. Hold them with right sides of knitting facing together. Insert a third needle into first stitch on each of the other two needles and knit them together as one stitch. *Knit next stitch on each needle the same way. Pass first stitch over second stitch. Repeat from * until one stitch remains on third needle. Cut yarn and pull tail through last stitch.

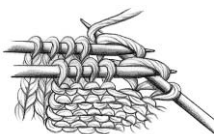

Slip-Stitch Crochet Seam

Make a slipknot with seaming yarn and place on a crochet hook. With RS of pieces facing each other, *insert hook through both pieces of knitting under the BO sts, wrap the yarn around hook to form a loop (Figure 1), and pull loop back through both pieces of knitting and through the loop already on hook (Figure 2). Repeat from *, maintaining firm, even tension.

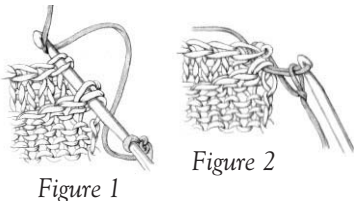

Crochet Chain (ch)

Make a slipknot on hook. Yarn over hook and draw it through loop of slipknot. Repeat, drawing yarn through the last loop formed.

Single Crochet (sc)

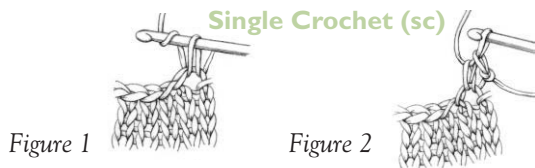

Insert hook into an edge stitch, yarn over hook and draw a loop through stitch, yarn over hook (Figure 1) and draw it through both loops on hook (Figure 2).

Slip Stitch Crochet (sl st)



Insert hook into stitch, yarn over hook and draw loop through stitch and loop on hook.

Reverse Single Crochet (rev sc)

Working from left to right, insert crochet hook into a knit edge stitch, draw up a loop, bring yarn over hook, and draw this loop through the first one. *Insert hook into next stitch to right (Figure 1), draw up a loop, bring yarn over hook again (Figure 2), and draw this loop through both loops on hook (Figure 3). Repeat from *.

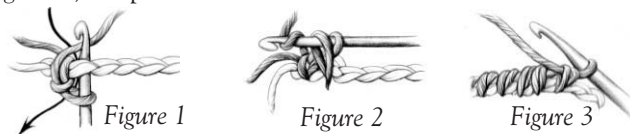

Half-Double Crochet (hdc)

Take yarn over hook, insert hook into a stitch, yarn over hook and draw a loop through stitch (3 loops on hook), yarn over hook (Figure 1) and draw it through all the loops on the hook (Figure 2).

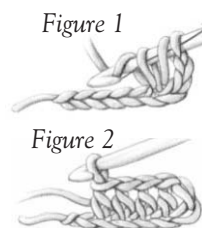

Double Crochet (dc)

Yarn over hook, insert hook into a stitch, yarn over hook and draw a loop through (three loops on hook), yarn over hook (Figure 1) and draw it through two loops, yarn over hook and draw it through the remaining two loops (Figure 2).

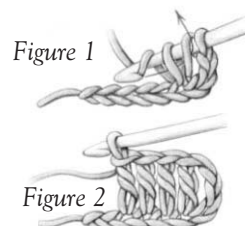

Treble Crochet (tr)

Wrap yarn around hook two times, insert hook into a stitch, yarn over hook and draw a loop through (four loops on hook; Figure 1), yarn over hook and draw it through two loops (Figure 2), yarn over hook and draw it through the next two loops, yarn over hook and draw it through the remaining two loops (Figure 3).

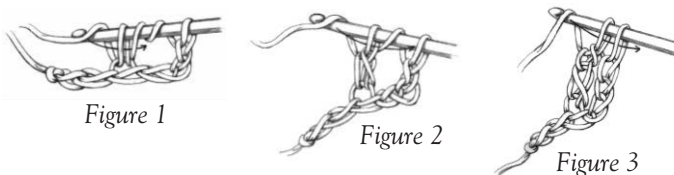

OOPS!

Visit our website at www.interweave.com for corrections to all issues of Interweave Knits.

FALL 2004

76-Stitches Hat (page 102)

The tune "76 Trombones" was composed by Meredith Willson, not Rodgers and Hammerstein.

SPRING 2005

Cable-Eight Top (page 66)

The instructions for the 4/2 Cable in the Stitch Guide should read: 4/2 Cable: (worked over 6 sts) Sl 4 sts onto cn and hold in front, k2, return 2 purl sts from end of cn back to left needle, p2 returned sts, k2 from cn (not [p2, k2] from cn as stated).



Knitter's Review

experience the world of yarn

Boutique

Knitting-themed gifts, accessories, and paper goods

Magazine

Free weekly online magazine for people who love yarn

Forums

Community of more than 36,000 knitters worldwide

www.knittersreview.com

When knitting matters, our technical articles are in-depth and plentiful.



Look for it on Newsstands or
Subscribe - 4 Issues yearly
for \$23.00 / \$26US to Canada

www.inknitters.com

800-628-8047

Fiber Circle Publishing •

1105 E. Plano Parkway, Suite 2 •
Plano, Tx USA 75074

Now with
Machine Knitting!

32 additional pages of patterns & articles were added to the Winter issue.

INKnitters
A RESOURCE FOR THE INDEPENDENT KNITTER

Judi & CO. *Imagine.... pure Color*

- Hand Dyed Ribbons for Knitting and More
- Handbag Kits using Cordé, Soutache, Satin Cord, or Rayon Raffia
- Large Selection of Purse Handles & Frames

Visit our web site:
www.judiandco.com

E-Mail us at:
judico@optonline.net

Wholesale Inquiries:
631-499-8480

Consider the possibilities...

Alpine	Deep Grape	Lodgegrass	Peach	Sierra
Bark Brown	Deep Blue	Lost Trail	Pheasant	Silverbow
Bitterroot	Evergreen	Manas Falls	Pine Needle	Spruce
Rainbow	Firestorm	Meadow		
Blue Green	Flathead Cherry	Midnight Sapphire		
Brick	Garnet	Moondance		
Burgundy	Glacier Teal	Mountain Twilight		
Canyon	Granite Peak	Mystic Lake		
Clearwater	Huckleberry	Natural		
Copper	Indian Corn	Northern Lights		
Crazy Woman	Ladyslipper	Obsidian		
	Larkspur	Olive		

45 Beautiful Colorways!
www.mountaincolors.com • (406) 961-1900

MOUNTAIN COLORS
HAND-PAINTED YARNS

Northeast FIBER ARTS Center

The candy store for knitters.
www.northeastfiberarts.com

subscribe to
INTERWEAVE
KNITS

and get FREE extra projects and features on our SUBSCRIBER-ONLY website.

Dibs on Ribs by Colleen Davis

www.interweaveknits.com
free patterns • resources • articles
events • books • tips

utterly knittable truly inspiring Interweave Books

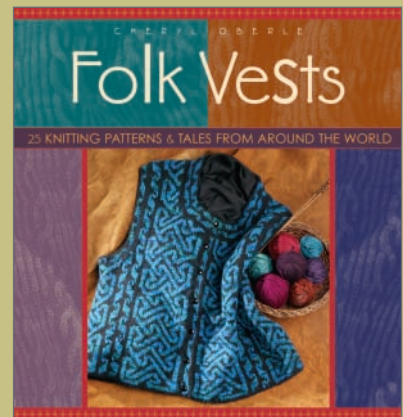
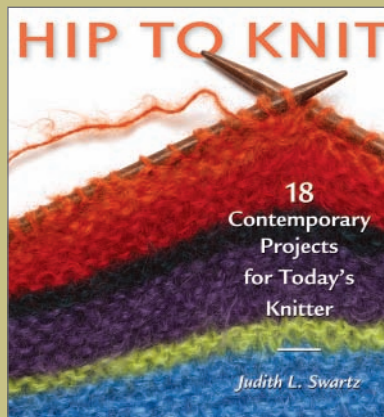
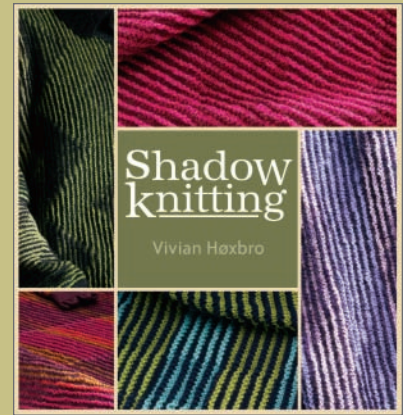

INTERWEAVE PRESS®

Over 100 fiber books at www.interweave.com
Also available at your favorite knit or book shop

sources for supplies

Contact the companies listed below if you don't know of a local retailer or mail-order source for the yarns used in this issue.

UNITED STATES YARN SOURCES

Alchemy Yarns, PO Box 1080, Sebastopol, CA 95473; www.alchemyyarns.com.
American Buffalo Products/Ruth Huffman Designs, Rte. 1, Box 14, Wynnewood, OK 73098; (405) 665-2717; (800) 501-4203; www.americanbuffaloproducts.com.
Aurora Yarns/Garnstudio, PO Box 3068, Moss Beach, CA 94038; www.garnstudio.com. In Canada: Aurora Yarns.
Berroco, Inc., 14 Elmdale Rd., PO Box 367, Uxbridge, MA 01569; www.berroco.com. In Canada: S. R. Kertzer, Ltd.
Blue Sky Alpacas, PO Box 387, St. Francis, MN 55070; www.blueskyalpacas.com.
Cascade Yarns, 1224 Andover Park East, Tukwila, WA 98188; www.cascadeyarns.com.
Cherry Tree Hill, Inc., PO Box 659, Barton, VT 05822; www.cherryyarn.com.
Classic Elite Yarns, 300 Jackson St., Lowell, MA 01852; www.classiceliteyarns.com.
Fiesta Yarns, 4583 Corrales Rd., Corrales, NM 87048; www.fiestayarns.com.
Great Yarns, 1208 Ridge Rd., Raleigh, NC 27607; www.great-yarns.com.
Henry's Attic, Inc., 5 Mercury Ave., Monroe, NY 10950; (845) 783-3930.
JCA, Inc./Reynolds, 35 Scales Ln., Townsend, MA 01469.
Knitting Fever, Inc./Debbie Bliss, 35 Debevoise Ave., Roosevelt, NY 11575; www.knittingfever.com. In Canada: Diamond Yarn.
Lion Brand Yarns, 34 W. 15th St., New York, NY 10011; www.lionbrand.com.
Lorna's Laces Yarns, 4229 N. Honore St., Chicago, IL 60613; www.lornaslaces.net.
Louet Sales/Gems, PO Box 267, 808 Commerce Park Dr., Ogdensburg, NY 13669; www.louet.com.

Morehouse Farm, 141 Milan Hill Rd., Milan, NY 12571; www.morehousemerino.com.
Muench Yarns, Inc., 285 Bel Marin Keys Blvd., Unit J, Novato, CA 94949-5763; www.muenchyarns.com. In Canada: Le fils Muench.
Plymouth Yarn Co., PO Box 28, Bristol, PA 19007; www.plymouthyarn.com.
Russi Sales, Inc./Heirloom, PO Box 4199, Bellingham, WA 98227; www.RussiSales.com.
South West Trading Co., 918 South Park Ln., Ste. 102, Tempe, AZ 85281; (408) 894-1818; www.soy silk.com.
Tahki/Stacy Charles, Inc./Filatura di Crosa, 30 80th St., Bldg. 36, Ridgewood, NY 11385; www.tahkistacycharles.com. In Canada: Diamond Yarn.
Unique Kolours/Colinette, 28 N. Bacton Hill Rd., Malvera, PA 19355; www.uniquekolours.com.
Westminster Fibers/Rowan, 4 Townsend West, Unit 8, Nashua, NH 03063; www.knitrowan.com. In Canada: Diamond Yarn.

CANADIAN YARN SOURCES

Diamond Yarn, 9697 St. Laurent, Ste. 101, Montreal, QC H3L 2N1 and 115 Martin Ross, Unit #3, Toronto, ON M3J 2L9; www.diamondyarn.com.
Fils Diamond Du Canada, 9697 Boul St. Laurent, Montreal, QC H3L 2N1.
Koigu Wool Designs, RR #1 Williamsford, ON N0H 2V0; www.koigu.com.
Le fils Muench, 5640 Rue Valcourt, Brossard, QC J4W 1C5; www.muenchyarns.com.
Louet Sales/Gems, RR4, Prescott, ON K0E 1T0; www.louet.com.
Patons, 320 Livingstone Ave., South, Listowel, ON N4W 3H3; www.patonsyarn.com.
S. R. Kertzer, Ltd./Naturally, 50 Trowers Rd., Woodbridge, ON L4L 7K6; www.kertzer.com.

Alchemy Synchronicity; singles; 11 wpi

Berroco Denim Silk; tubular ribbon; 10 wpi

Blue Sky Alpaca 100% Organic Cotton; 2-ply; 10 wpi

Cascade Sierra; three 2-ply strands; 11 wpi

Cherry Tree Hill Supersock Solids; 2-ply; 17 wpi

Classic Elite Premiere; 4-ply; 12 wpi

Colinette (Unique Kolours) Giotto; ladder ribbon; 3 wpi

Debbie Bliss (Knitting Fever) Cathay; twelve 2-ply strands; 13 wpi

Devon (Great Yarns) Julia; 4-ply; 10 wpi

Fiesta Yarns La Boheme; two (4-ply and 2-ply) strands novelty; 11 wpi

Filatura di Crosa (Tahki/Stacy Charles) Millefili Fine; eight 2-ply strands; 18 wpi

Garnstudio (Aurora Yarns) Muskat; thirteen 2-ply strands; 13 wpi

Gems (Louet) Pearl; 2-ply; 17 wpi

Heirloom (Russi Sales) 8-Ply Cotton; 3-ply; 16 wpi

Henry's Attic Alpine Cotton; 3-ply; 14 wpi

Koigu Premium Merino; 2-ply; 17 wpi

Lion Brand Cotton Ease; four 2-ply strands; 10 wpi

Lion Brand Fun Fur; chain; 15 wpi

Lorna's Laces Shepherd Sock; 4-ply; 20 wpi

Morehouse Farms Merino 2-Strand; 2-ply; 15 wpi

Muench Mystic; six 2-ply strands; 13 wpi

Naturally (S. R. Kertzer) Kid et Soie; 4-ply; 11 wpi

Patons Katrina; five 2-ply strands; 11 wpi

Plassard Twingo; novelty chain wrapped puffs; 11 wpi

Plymouth Royal Cashmere; five 2-ply strands; 13 wpi

Reynolds (JCA) Saucy Sport; three 2-ply strands; 17 wpi

Rowan (Westminster Fibers) Lurex Shimmer; 2-ply chain; 21 wpi

Rowan (Westminster Fibers) Rowanspun 4 Ply; 2-ply; 19 wpi;

Rowan (Westminster Fibers) Yorkshire Tweed 4 Ply; 2-ply; 16 wpi

Rowan (Westminster Fibers) Wool Cotton; four 2-ply strands; 13 wpi

Ruth Huffman Designs American Buffalo 2 Ply; 2-ply; 17 wpi

South West Trading Oasis; tubular ribbon; 12 wpi

Tahki New Tweed; 8-ply; 10 wpi

THE KNITS MARKETPLACE

RESOURCE GUIDE

What's In Your Bag?

Beaded Stitch
Markers
Needle Organizers
Tip Protectors
Scissor Fobs
LavaLieres

Phone (954) 316-6609
Fax (954) 316-4509
Email ~ Hipchicsknit@aol.com
Web ~ WWW.HIPCHICKSKNIT.COM

HIP
CHIC'S
KNIT



The Elegant Ewe
New England's Knitting Capital

Our Unique Designs & Kits for Knitting and Crochet are available online at www.elegantewe.com

Just Off I-93, Exit 13 in Historic Downtown Concord
71 South Main Street, Concord, NH 03301
603-226-0066

Ashland Sky
Knit Stick Sacks



For a retailer near you visit: www.ashlandsky.com
For wholesale information: 541.482.3390

Lakeside
Fibers

Extensive Yarn Selection
From Organic to Exotic

Classes, Supplies, and Support for Knitters, Weavers & Fiber Artists

A Working Studio

402 W Lakeside Street
Madison, WI 53715
Phone: (608) 257-2999
www.lakesidefibers.com

Secure online ordering on our website

Stop by & see the view - and our expanded selection!

the organized knitter
handmade knitting needle cases



order online at www.organizedknitter.com

NATURAL FIBER YARNS
at their luxurious best!



GREEN MOUNTAIN SPINNERY

Mountain Mohair • Cotton Comfort
Alpaca Elegance • Sylvan Spirit
GREEN MOUNTAIN GREEN & more
Catalog & Yarn Samples \$8.00

GREEN MOUNTAIN SPINNERY
P. O. Box 568 Putney, VT 05346 tel 802.3874528 or 800.321.9665 e-mail spinnery@sover.net
Ask at your local yarn shop or Order Online at www.spinnery.com

Wool Pak • Brown Sheep • Koigu

Susan's Fiber Shop
www.susansfibershop.com



Tired of the regular knitting yarn? Why not make your own? Susan's has a great selection of spinning wheels!

13 miles from Madison by E. Bristol
N 250 HWY. A, COLUMBUS, WI 53925
Ph: (920) 623-4237 Orders: (888) 603-4237

Cascade • Plymouth
Regia • Noro Yarns
Mountain Colors • Fixation • Berrocco

Exquisitely Angora
by Rosahé Truong
Specializing in
Handpainted Yarns



1222 Mackay Place
St. Louis, MO 63104
Phone: 314.771.6302 FAX: 314.776.3785
www.angorayarn.com
fuzzme@angorayarn.com
314-771-6302
Pamphlet and Samples \$8.00

THE KNITS MARKETPLACE

RESOURCE GUIDE



Glory-ous Knits

Psalm 139:13

Only the best...

- Famous Brands
- Natural Fibers
- Novelty Yarns
- Exotic Yarns
- Hand Paint Yarns
- Others.

15 Harris Circle • Watsonstown, PA 17777
Phone/Fax: (570) 437-4139
www.glory-ousknits.com
Email: customerservice@glory-ousknits.com
FREE shipping on \$50 or more.



the weaving works

4717 Brooklyn Ave NE
Seattle, WA 98105

supplies/classes/books

web site: <http://www.weavingworks.com>
 orders: 1-888-524-1221 info: (206)-524-1221 fax: (206)-524-0250

basketry
book arts
dyeing
knitting
papermaking
spinning
surface design
textile arts
weaving

Cheryl Oberle Designs

Hand-painted Knitting Kits for
Sweaters, Vests, Shawls and Socks
Color Samples
and Brochure \$10
(Refundable with Order)

www.cheryloberle.com
 cheryl@cheryloberle.com
 3315 Newton St
 Denver, CO 80211
 303-433-9205



Genuine Purl

140 N. Market Street
Chattanooga, Tennessee 37405

"The knitter's jewel of the South"

*You have got to see us to believe us!
 We have a great selection
 along with friendly service and expert advice. We ship daily.*

Call the "Purl Girls"! 1-800-862-2890

Knitting Basket Lake Tahoe

**PATCHWORK
 (modular) PATTERNS**
 by Irene York

9 pattern booklets available
at \$11.95 each.

See pattern collection at
www.knittingbasket.com
 or
 request catalogue by calling
1.800.252.YARN

*wholesale
inquiries
welcome*



DRAGON TALE YARNS

from
EARTH GUILD



- 16 colors: 10 solids & 6 rainbows, on 8 oz cones
- 4 matte cottons, 4 lustrous rayons, smooth & textured
- including rayon chenille
- weave, knit & crochet: garments, linens & artwork
- samples \$1 postpaid, or see our web-site for colors
- available at fine yarn shops

EARTH GUILD • 33 Haywood Street • Asheville NC 28801
www.earthguild.com • 1-800-327-8448 • inform@earthguild.com

Taos Sunflower Specialty Yarns
 PO Box 506 Arroyo Seco NM 87514
 10 min North of Taos on the Ski Valley Rd



Dear Olive:
 They've expanded the shop and added
 new yarns! You must come back ASAP...
 XO XO JB

505.776.5644 www.taosunflower.com

Weave in the Palm of Your Hand

Buxton Brook Looms offers a wide range of products for your weaving pleasure.

- Weavette Looms
- Weaving Needles
- Folding Scissors
- Yarn Keeper
- Sportfolios
- Modular Textures: Patterns for the Weavette & Weave-It Loom



1382 WEST MAIN ST., WILLIAMSTOWN, MA 01267

BUXTON BROOK LOOMS

WEAVETTES.COM ♦ 413 458 2782

THE KNITS MARKETPLACE

RESOURCE GUIDE

The Fiber Studio
New Hampshire's Leading Fiber Arts Store

- ◆ Sock Yarns ◆ Hand Painted Rayon Chenilles, Rayons, Mohair, Ribbons ◆ Famous Maker Knitting Yarns ◆ Patterns ◆ Books ◆ Classes ◆ Looms ◆ Spinning & Felting Fibers & Equipment

 Yarn Samples \$6.00/set Spinning Fiber Samples \$5.00/set
9 Foster Hill Rd., PO Box 637-Iwuk Henniker NH 03242 603-428-7830
open Tues-Sat 10-4 Sun by Chance
www.fiberstudio.com sales@fiberstudio.com

k n i t w e r x . c o m

the ultimate online yarn shopping experience.

knitwerx.com

DISTRIBUTORS OF FINE YARN



HIMALAYA YARN

149 MALLARD DR.
COLCHESTER
VT 05446
(802) 862-6985
<http://himalaya-yarn.home.att.net>
himalaya-yarn@att.net

Yarns from Nepal

Wholesale & Retail
For retail see our "list of stores" on our website or call.

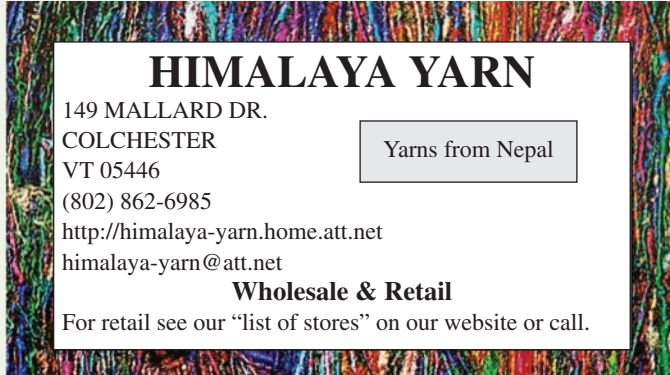

string



chic. fun. yarn.
1015 madison avenue new york, ny 10021 • 212.288.yarn
www.stringyarns.com

Yarn Cellar

Bags, books, accessories

Manos and Rowan and Noro—oh my!

Come see our original Rosie Knits patterns and kits

www.rosiesyarncellar.com
or call (215) 977-9276
Philadelphia, PA

New on-line sale every week

WWW.ANGELHAIRYARN.COM

*We've moved!
Bigger and better!
More of what you love about AHYC!*



ANGEL HAIR YARN CO.
4117 Hillsboro Pk., #102
Nashville, TN 37215
(615) 269-8833

I N T E R W E A V E

KNITS

looking for a free pattern?

www.interweave.com



THE KNITS MARKETPLACE

Premier Classifieds

ACCESSORIES

Hug Me Company 800.308.3051

Hand Made Knitting Bags
High quality bags for
knitters in a myriad
of beautiful
designer
fabrics and
styles.



www.hugmeco.com

ACCESSORIES



Row Counter

- Adds & Subtracts
- Electronic, 4 digit
- Soft beep (on or off)
- 16" neck lanyard
- Weighs one ounce
- 2-3/8" x 1-1/4"
- Long life battery



Yarn Meter - Affordable

A meter for measuring your
yarn's length. Includes 1.75"
table clamp & hardwood base.

Nancy's Knit Knacks
nancysknitknacks.com
800-731-5648 Whse Welcome

EVENTS

Pagosa Fiber Fest

May 28-29, 2005
Workshops: May 26-31
Pagosa Springs, CO

For info, call
(970) 254-4543

www.pagosafiberfestival.com

BUTTONS



One-of-a-kind
Fused Glass Buttons
www.perfectbuttons.com
505.286.1783

KITS

ARTFUL KNITTING

new beading and
knitting techniques for
day and eveningwear

kits, specialized
yarns, workshops by
designer Laura Glazier

visit www.artfulknitting.com to learn more

Sheep Needle Gauge by The Elegant Knitter at *Goose Pond* www.goosepond.com



800-340-2514

ask about our
sterling-silver
stitch markers

\$15.00 + shipping

0000 to 15 US &
metric sizes with a 2"
stitch/row gauge

wholesale inquiries welcome

Solid brass with a tarnish-free lacquered finish

Looking for Some Closure?

over 500 buttons in stock

Call Us 800.290.2739

sawyerbrook.com

Supremely Beautiful Seriously Functional

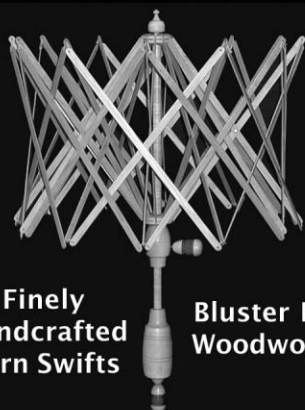

Finely
Handcrafted
Yarn Swifts

Bluster Bay
Woodworks

FREE COLOR BROCHURE

907-747-7533 or BlusterBay@Alaska.com

EMPLOYMENT

SEARCHING FOR A NEW CAREER? Enjoy the excitement of seasonal collections, new products and the satisfaction of being creative. Join our industry-leading team as a commissionable full or part time sales representative for established and new accounts!

Potentially available lines are: Addi Turbo Needles, Schoeller+Stahl Yarns, Austermann Yarns, Zitron Yarns, Skacel Yarns, Schulana Yarns, Peter Gregory Patterns and more!

- Call "Rob" for open territories •
- Extensive travel is required •



Skacel Collection, Inc.

(800) 255-1278

info@skacelknitting.com

THE COUTURE KNITTING WORKSHOP

kits, fibers, and notions

Catherine Lowe's couture knitting workshops and retreats
The Ravell'd Sleeve

for complete information

visit www.thecoutureknittingworkshop.com

or write to PO Box 209, East Chatham, NY 12060

THE KNITS MARKETPLACE

PREMIER CLASSIFIEDS

LITERATURE

Knitting Pattern
Books
**SHOE BOX
DOLLS**



Betty Lampen, Dept IK

2930 Jackson St.,
San Francisco, CA 94115-1007

Books \$7 each, postage included

CA residents include tax.

US funds only. Credit Card acc
through PayPal.

<http://www.bettylampenknitbooks.com>

Knitting in the Old Way

by Priscilla A. Gibson-Roberts
& Deborah Robson

At your favorite yarn shop or book store
Ask for Simple Socks, Plain and Fancy, too!

 www.nomad-press.com

WEBSITES TO VISIT

Hand-crafted
Surina wood
knitting
needles

from
India

www.paradisefibers.com

**amazing selection of natural yarns,
patterns, kits, and accessories.**

*silk, wool, cotton, linen, mohair, rayon,
alpaca, funky, traditional, and more.*

check out our
weekly special,
bargain corner,
closeouts,
and odd balls!



949.716.8436

www.onefineyarn.com

Chilly Toes?

Cool Socks Warm Feet

A 128-page book with great sock
recipes and more by *Lucy Neatby*.

At yarn stores or www.tradewindknits.com



YARNS

Experience
knitting with us!

**Common
THREADS**

knittingclub.com

888-234-9592

Mention this ad - receive **FREE** shipping

**The Fibre
Company**

finely crafted in the Maine tradition

Luxurious & Colorful
Unique Artisan Quality Yarns

www.TheFibreCo.com

Soft Wool Yarn!

Worsted, Sportweight, and Bulky in
natural & 45+ colors

Visit our sheep farm and knitting shop
or order by mail, telephone, and e-mail.

Yarn samples \$5. Refundable with order.

MasterCard/VISA



BOVIDAE FARM

1608 Jarvis Branch Rd.
Mars Hill, NC 28754 • 828-689-9931
email bovidae@madison.main.nc.us

SUPPLIES

hemp for knitting™

yarns fibers
designer patterns

inspired by the natural beauty of hemp

info@lanaknits.com Lanaknits Designs
www.hempforknitting.com 1-888-301-0011

YARNS

Marr Haven Wool Farm
Quality Products for All Fiber Artists

- Merino-Rambouillet Wool Yarn
- 100% Chemical Free & Dyed Colors
- Knit, Crochet, Locker Hook & Felt Supplies

Handmade Natural Personal Items

- Sheepskin Slippers • Sheep Jewelry
- Goatskin Garden Gloves



772 - 39th St, Dept. IK
Allegan, MI 49010
269-673-8800

www.marrhaven.com

THE KNITS MARKETPLACE

PREMIER CLASSIFIEDS

YARNS

The Yarn Barn

Your #1 Source For Yarn, Needlepoint & Accessories

Free Shipping
on Kits From This Issue



Visit us @
24 Seldon St.
Woodbridge, CT 06525
(203) 389-5117
For orders only, call
(877) 299-5245
<http://www.theyarnbarn.com>

Dancing Leaf Farm

Color Splashed Yarn
Painted on the Farm



301-801-6995
Barnesville, Maryland
www.DancingLeafFarm.com



Discover the luxury of natural fiber yarns at

Carodan Farm Wool Shop

156 Shepherds Hill Road • Stanardsville, VA 22973
(800) 985-7083 carodan@direcway.com

- Noro • Skacel • Lorna's Laces • Debbie Bliss
- Cascade • WoolPak • Peer Gynt
- Dale of Norway *Sock yarns:* • Trekking
- Opal • Regia • Blauband • Mt. Colors • Lang

Visit our country store on-line where we are always open
www.carodanfarm.com

Register on our website to receive e-mail newsletter

YARNS

Three Black Sheep

A YARN SHOPPE
155 MAIN STREET • NORTHPORT, NY 11768

631.262.YARN (9276)
www.threeblacksheep.com

a EWENIQUE SHOPPE in a
CUTE LITTLE TOWN on the WATER
with WONDERFUL STUFF for
KNITTERS • Come Visit!



Lady Peddler

Now Available: *Furlana Yarns*

Merino 80%/Possum Yarn 20%
Worsted Spun & Bouclé.

Merino 50%/Possum 40%/Silk 10%
Woolen Spun Lace Weight (from New Zealand)

Yarns ~ Novelty Yarns ~ Fine Wools
Mohair Bouclé & Brushed Mohair
Spinning Wheels • Ashford & Louet
Knitting Needles • Bamboo
Dyes • Books • Videos • Post Cards

Quality Fibers ~ Fine Wool ~ Ramie Cotton
~ Alpaca ~ Silk ~ Flax ~ Angora

Quality Fiber Blends ~ Merino/Silk
~ Merino/Possum (from New Zealand)
~ Fine Wool/Angora ~ Fine Wool/Mohair

Available at the shop ~ mail, phone, or website.
142 E State St., Hastings MI 49058
1-800-948-6689
www.ladypeddler.net • ladyp@iserv.net

YARNS

Summer Workshops!

with Patricia Spark

Felt Lamination with Silk Scarves
1-day workshop, June 3rd

Color and Imagery in Feltmaking
2-day workshop, June 4th-5th

Check our website for upcoming workshops!



the yarn tree

A FIBER ARTS STUDIO • STORE
347 Bedford Ave, Brooklyn, NY 11211
(718) 384-8030 www.theyarntree.com

BRING LIFE Into YOUR KNITTING!



Affordable Prices

At **WoolGatherers, LLC**
for Yarn from

- *Mountain Colors *Lorna's Laces
- *Berroco *Crystal Palace *Trendsetter

Phone us at **1-800-461-8288**

or visit our eBay Store

www.stores.ebay.com/woolgatherersllc



The goods &/or services described above are those of an eBay Stores seller, not eBay Inc. eBay and the eBay Stores logo are trademarks of eBay Inc.

Habu specializes in one-of-a-kind textiles & unique yarns/materials from Japan. Over 300 selections of yarns include bamboo, silk/wool stainless steel, paper, metallic and many more. A variety of knitting & crocheting kits are available also. The store is open from 10 am to 6 pm (Mon. to Sat.). A complete yarn sample set is available for \$20 (+\$2 postage within US & \$10 will be refunded on your 1st order over \$60.)

Habu Textiles

135 W. 29th Street, Suite 804, NY, NY 10001
212.239.3546 telephone 212.239.4173 facsimile
habu@habutextiles.com e-mail
www.habutextiles.com

INTERWEAVE KNITS

Your Display Ad
Could Be Here!!!

This is the readership you
have been looking for!

Call Knits Advertising,
Attn: Tiffany Zerges,
(877) 669-7455 for more
information

THE KNITS MARKETPLACE

CLASSIFIEDS

ADVERTISING

TO PLACE A CLASSIFIED AD for an upcoming issue, send your ad with payment by the following deadline date: Fall 2005 by May 11, 2005. **Only \$2.50 per word (\$50 minimum).** Payment must accompany ad. Visa, MC, AMEX, Discover accepted with account number and exp. date. Send to **Interweave Press, KNITS Classified Ads**, 201 East Fourth Street, Loveland, CO 80537-5655. Fax (970) 667-8317 or email CorinaM@Interweave.com.

BUSINESS OPPORTUNITIES

HAVE YOUR PASSION PAY for itself. Seeking knitters with entrepreneurial spirit for a ground floor opportunity. Visit our website www.knitability.com/opportunity.html.

INSTRUCTION

JOHN C. CAMPBELL FOLK SCHOOL offers knitting, fiber arts, and other craft classes. Free catalog: One Folk School Road, Brasstown, NC 28902. (800) 365-5724; www.folkschool.org

LIGHTING

OTT-LITE LAMPS! Full spectrum, True Color. Terrific for Color Matching. Discount Prices!!! Check out our website www.lumenlight.com; (800) 742-4289.

LITERATURE

HUGE SELECTION NEW & OUT-OF-PRINT knitting and other needlework books. Free catalogs and newsletter: **Ruth Kern Books**, PO Box 35366, Phoenix, AZ 85069. Free book searches. (800) 429-5075; fax (602) 944-1753; rkern3@mindspring.com; www.needlearts.com.

MAIL ORDER

NATURAL FIBER, YARNS & KITS. Lace shawls, socks and more. Addi, bamboo, rosewood and ebony needles. Unique accessories, latest and classic books. **Catherine Knits**, (718) 836-6439, www.CatherineKnits.com.

PEG'S LEGS HAND-KNIT DANCEWEAR. Patterns for leotards, legwarmers and more! Book \$10.95 plus \$2.00 postage/handling. (650) 320-8094; vivavox1@aol.com

NOTICES

BOOK? CATALOG? INSTRUCTIONS? Yes! Editing, typography, layout, design, photography, digital pre-press, web sites, and marketing. **AdSense Consulting**, www.adsense.com, (541) 686-1806, info@adsense.com.

PATTERNS

CLASSIC CHRISTMAS STOCKING PATTERNS. Long thought destroyed in 1961 fire. Designed by Grace Ennis from 1948-1951 this complete set of 6 classic Christmas designs can be yours for \$12.98+\$1.98 postage \$14.96 total. Visit **Graphic Knitting Patterns** website www.grkp.com or send check or money order to **Graphic Knitting Patterns**, 519 Norwich Drive, West Hollywood, CA 90048. Questions call (310) 657-5680.

KNITTED LACE PATTERNS! Six pattern books. Create your own heirlooms. **Heirloom Lace**, 109 W. Fourth St., Hermann, MO 65041; (573) 486-2162; Knitlace@ktis.net; www.Knitlacepatterns.com.

SOCKS

SOCK IT TO ME Shoe Size to Sock Length Conversion Guide. A sock knitters dream tool. U.S., European & Mexico shoe sizes converted into inches & centimeters for women, men and infants/children. Laminated 4.25" X 10 1/8". \$6.99 each, postage paid. CA residents add sales tax. U.S. funds only, check or M.O. **SOCK IT TO ME**, P.O. Box 1297, Shingle Springs, CA 95682. For wholesale orders call (530) 621-9527 or Bryson Distributing (800) 544-8992.

SOCK OF THE MONTH CLUB at TheKnitter.com. Join our sock club and receive a different yarn and an original pattern, either monthly or bi-monthly. \$16.95/kit. Free shipping to US and Canadian addresses. See us on the web at www.theknitter.com or phone (303) 530-1845 for details.

SPECIAL EVENTS

4TH ANNUAL NATURAL FIBRE FESTIVAL, Salt Spring Island, BC-Canada's fibrecrafts island. Exceptional! Workshops July 20-22, Festival July 23-24. Information, www.fibrefestival.com.

COME TO A KNITAWAY. Knitting retreats/workshops in beautiful settings. **Knitaway in Taos**, New Mexico: May 4-8, Sept. 29-Oct 3, or Oct 5-9, 2005. Contact **Cheryl Oberle**, 3315 Newton St., Denver, CO 80211. (303) 433-9205; cheryl@cheryloberle.com; www.cheryloberle.com

KNITTING GETAWAYS, Sep 28-Oct 2 near SF/Sacramento; Oct 26 Shelburne, VT. More info visit www.y2knit.net.

MINNESOTA KNITTERS' DAYS October 28, 29, 30, 2005 with Candace Eisner Strick, Historic Villa Maria in Frontenac, Minnesota. Call (651) 388-2905 or sherknits@yahoo.com.

TRAVEL

2006 EASTER IN THE ANDES. Travel to Peru and Bolivia in 2006 with authors and experts Cynthia LeCount and Nancy J. Thomas. A real behind the scenes adventure for knitters and weavers. April 7 to 21. www.btsadventures.com; email: lacynthia@vom.com.

KNAUTICAL KNITTERS. Cruise the Baltic with Galina A. Khmeleva and Merike Saarnit in July 2006. Also inquire about our fiber trips to New Zealand. For details visit www.craftcruises.com or contact Melissa Werner (800) 682-1988 x239; melissa.werner@comcast.net.

WEBSITES TO VISIT

EXCITING FASHIONS, IDEAS AND YARNS. **Knitting Basket Lake Tahoe.** www.knittingbasket.com; yarn@knittingbasket.com; 1-800-252-YARN

WWW.ABBEYARNS.COM. 2-ply, worsted weight yarn, imported from Ireland, sold direct to knitters. Request colorcard online, view yarn, patterns, kits, buttons.

WWW.ELANN.COM. Brand name yarns at up to 75% off. Register at our website to receive a free introductory copy of our closeouts newsletter.

WWW.HANDSPUNYARN.COM will take you to the website of Arcata Bay Llamas. We offer Hand-spun/Hand Dyed Yarn, Hand Knit Caps, Ready to Spin Fiber, and Knit Kits with our original Cap patterns. info@arcatabayllamas.com

WWW.KASPAREKS.BIZ. Art rubber stamps for passionate knitters. Personalize your cards, journals and gift enclosures with **Kaspareks** original, hand-drawn designs that will capture the spirit of your craft. **Kaspareks**, PO Box 748, Berkeley, CA 94701.

YARNS

ALPACA! NATURAL & DYED knitting yarns, kits. **West Valley Alpacas**, 19190 Road 87B; Esparito, CA 95627. (530) 662-8630; www.westvalleyalpacas.com.

ALPACA YARNS. Novelty, silk blends, sockweight, patterns. Naturals and brilliant dyed colors. Teddy bears, roving, sweaters, accessories. www.GenesisAlpacas.com; (360) 659-1990. Free shipping. Coupon code W04KN for 10% discount.

CHASING RAINBOWS DYEWORKS hand-painted yarns and fibers. Matching solids available. Wholesale inquiries welcome. 1700 Hilltop Dr., Willits, CA 95490; (707) 459-8558; nancyscrd@saber.net. Wool, mohair, silk blends.

CUSTOM HAND-DYED YARNS for knitters, crocheters and weavers. You choose the yarn, you choose the color way. Go to www.McRayWeaving.com.

HAND-PAINTED YARNS. Create a garment like no other from unique, hand-painted yarns dyed in small batches. No two yarns alike. **Spirit Trail Fibers**; www.spirit-trail.net, info@spirit-trail.net, (703) 309-3199.

HANDSPUN NOVELTY YARNS. Unique yarns for that special project. Wool and other natural fibers. Handcrafted in Kentucky. **Houndscroft Farm** www.houndscroftfarm.com.

LLAMA AND ALPACA YARN millspun, 2-ply natural colors and blends. Please visit our website: www.rmlfiberpool.com. **Rocky Mountain Lama Fiber Pool**, (719) 539-7185; 15760 County Road 220; Salida, CO 81201. MC VISA

100% CASHMERE FROM RIVERSONG: exquisite fibre from our prize winning herd. Top, roving, yarn-farm direct pricing. www.3.telus.net/river-song; (250) 249-0245; riversong@telus.net.

THE KNITS MARKETPLACE

YARN SHOP DIRECTORY

ALABAMA

Knit Nouveau—Helena

Eclectic & inviting shop with helpful staff, fine yarns, & unique patterns. www.knitnouveau.com
4094 A Helena Rd. (205) 664-5858

ALASKA

The Bead and Yarn Shoppe—Ketchikan

Located on the cruise ship dock in Ketchikan, Alaska. Large selection of specialty yarns and beads. www.alaskabeadstore.com
5 Salmon Landing, Ste. 213 (907) 225-2858

ARIZONA

Unravel Yarn and Fiber Arts—Flagstaff

Unique local and regional yarns and supplies. Wide selection of needles. www.unravelshop.com
6 West Route 66 (928) 556-9276

Fiber Factory—Mesa

The Southwest's most complete yarn shop. Yarn, accessories, equipment & classes. www.fiberfactory.com
150 W. Main Street (480) 969-4346

The Fiber Shop—Prescott

The most varied and eclectic collection of yarns in Northern Arizona plus Addi Turbo.
208 N. McCormick (928) 445-2185

Purls—Tucson

Fine Knitting Materials. Your source for Jo Sharp Collection, Rowan and Trendsetter. 2 Locations!
7862 N. Oracle Road (520) 797-8118
7810 E. Speedway Blvd. (520) 296-6363

ARKANSAS

The Handworks Gallery—Little Rock

Visit us at www.handworksgallery.com and view the latest from Vittadini, Rowan, Goddess yarns and more!
2911 Kavanaugh Blvd. (877) 614-1191

CALIFORNIA

Ball & Skein & More—Cambria

Hand dyed, natural fibers, fashion yarns. Located seven miles south of Hearst Castle. Open Daily.
4070 Burton Drive (805) 927-3280

Skein Lane—El Cerrito

Inspiring selection of yarns, needles and accessories for knitters, crocheters and needleworkers. Visit us in the shop or at www.skeinlane.com.
7512 Fairmount Ave. (510) 525-YARN

Ancient Pathways—Fresno

A warm, friendly yarn shop where you will find color and texture in many fibers.
1294 N. Wishon (559) 264-1874

Knitting in La Jolla—La Jolla

Fine yarns (KIC2, Trendsetter, Colinette, Rowan, and more). Buttons, Patterns, Books, Cheerful Assistance. Mail Order.
909 Prospect St. (858) 456-4687

Continental Stitch—Morgan Hill

Elegant Yarns • Personal Service • Expert Finishing. Wonderful collection of fine yarns, accessories for your knitting pleasure.
17490 S. Monterey Rd. (408) 779-5885

Wildfiber—Santa Monica

Unique store with a large selection of yarns and accessories for knitting and crocheting.
1453-E 14th Street (800) 382-7067

Knitting Arts—Saratoga

Fabulous selection of yarns, books, notions, buttons, ribbon. Classes for all levels. Open 7 days. www.GoKnit.com
14554 Big Basin Way (408) 867-5010

Fashion-Knit—Walnut Creek

Fine yarns, accessories, patterns, classes. M,T,W & FR 10:30–6:30, TH 10:30–8, SA 10–5, SUN 12–4. www.fashionknit.net
1538 Newell Ave. (925) 943-3994

COLORADO

Coppelia's Needlepoint & The Shivering Sheep—Denver

Established 1993. Specializing in hand-painted needlepoint canvas. Custom designed knitting patterns. Contemporary knitting yarns, and unique yarns from Colorado's llamas and alpacas. Plus a large selection of books to choose from!
231 Milwaukee St. (303) 320-7776
Cherry Creek—North

The Indigo Thread—Fort Collins

Spinning, knitting, and weaving supplies, equipment, fibers, yarns, dyes and workshops. Quality, selection, excellent prices.
3307 S. College Ave. (970) 225-8001

Woolen Treasures Yarn Shop—Loveland

Cherry Tree Hill, Interplacements, Blue Sky Alpacas. Home-made buttons. Classes available. Located just 3 blocks east of Interweave Press!
447 E. 4th St. (970) 613-0556

CONNECTICUT

Mystic River Yarns, LLC—Mystic

Classes, workshops. Yarns range from basic to exotic. Personal service by expert knitters. Pleasant ambiance.
14 Holmes Street (860) 536-4305

DELAWARE

Stitches With Style—Wilmington

Fantastic selection of high quality yarns, needles, books, buttons, and notions. Friendly service and classes.
16-E Polly Drummond Shopping Center (302) 453-8130

FLORIDA

The Yarn Tree—Hollywood

The only place for knitters. Unique selection of natural fibers and novelty yarns. Wide selection of books, patterns, needles and much more.
2000-3 Harrison St. (954) 921-1160

Uncommon Threads—Palm Harbor

Catering to the fiber arts of knitting, crocheting, weaving, spinning. Basic to funky yarns, fibers.
31962 US 19 N. (727) 784-6778

IDAHO

Sheep to Shawl—Twin Falls

Described as: "A great shop", "a dream come true", "worth the drive!".....Yarn, needles & patterns galore! yarnandthreads.com
612 Main Ave. North (208) 735-8425

ILLINOIS

Arcadia Knitting—Chicago

Wide selection of needles, classes, books. Visit www.arcadiaknitting.com for hours and directions. Plenty of parking!
1211 W. Balmoral (773) 293-1211

Mosaic Yarn Studio, Ltd—Des Plaines

Helpful, knowledgeable staff; unique patterns and yarns, Addi Turbo Needles, workshops, special events, classes. www.mosaicyarnstudio.com
1585 Ellinwood St. (847) 390-1013

Yarn Sellar—Loves Park

We stock fine yarns from Berroco, Trendsetter, Dale of Norway, Tahki & more!
6128 E. Riverside Blvd. (815) 637-9666

Kool Knits—Naperville

A Kool place for yarn and needlepoint supplies!
232 S. Washington (630) 983-6310

Wool, Warp & Wheel—Richmond

Spinning, weaving, and knitting supplies and equipment. We feature looms and yarns by Harrisville Designs and Baynes Spinning Wheels. Open Tu–Fri 7p to 9p; Sat–Sun 10a–5p. www.woolwarpandwheel.com
5605 Mill St. (815) 678-4063

INDIANA

Cass Street Depot—Ft. Wayne

Historical train station. Large selection of specialty and traditional yarns. Inspiring books and patterns.
1004 Cass St. (888) 420-2292

RiverWools....A Knitting Place—Terre Haute

If you knit, crochet or would like to, you'll love our yarns, tools, books and classes!
671 Wabash Ave. (812) 238-0090
(866) 889-6657

IOWA

Creative Corner—West Des Moines

Complete Needlework Center. Knitting, crocheting, needlepoint, embroidery, count thread, rugs, latest unique ideas. creativecorner1@aol.com; www.creativecorner.net.
332 Fifth St. (800) 277-8427

KANSAS

Gove City Yarns & Antiques—Gove

Specialty yarns featuring pure Kansas yarns-spinning-old buttons & more. I-70 exit 93-10 miles south.
319 Broad St. (785) 938-2255

MAINE

Halcyon Yarn—Bath

One stop shopping for all your knitting needs: yarn, needles, notions, books, etc. • service@halcyon.com • www.halcyonyarn.net.
12 School Street (800) 341-0282

MARYLAND

Folk Art Studio Cafe—Bowie

Artisan Yarns, Coffee House & Art Studio to fill every practical luxury & functional addiction. www.folkartstudiocafe.com
6700 Race Track Rd. (301) 809-0193

THE KNITS MARKETPLACE

YARN SHOP DIRECTORY

Y2Knit–Funkstown

Visit us in historic Funkstown, MD. Fabulous yarn, Y2Knit patterns. www.y2knit.net

100 E. Baltimore St. (301) 766-4543

MASSACHUSETTS

Woolcott & Co., Inc.–Cambridge

In the heart of Harvard Square! Great selection—Natural fibers—Novelty Yarns—Patterns—Accessories—Classes. www.woolcottandco.com

61 JFK Street (617) 547-2837

The Woolpack–Littleton

Yarn for Yarn? Unwind your mind and knit yourself silly in our cozy fiber mercantile.

676 Great Road (978) 952-2500

Webs–Northampton

Your source for the finest in weaving, spinning and knitting supplies. Visit us at www.yarn.com.

75 Service Center Road (800) 367-9327

MICHIGAN

Busy Hands–Ann Arbor

Artful Yarns, Reynolds, Vittadini, Kertzer, Fonty, Needful and Heirloom. Classes. Specializing in exceptional customer service!

306 S. Main St. Suite 1-C (734) 996-8020

City Knits–Detroit

THE BEST PLACE FOR YARN IN DETROIT! Color nirvana-gourmet fibers. Buttons/needles/books/classes. Fisher Building. www.cityknits.com

3011 W. Grand Blvd., Suite C-9 (313) 872-9665

Wildwood Knit Shop–Norton Shores

Largest selection of wool in west Michigan! High quality yarns; eyelash, cotton, etc. Supplies/Patterns/Books/Classes. www.wildwoodembroidery.com

4590 Grand Haven Rd. (231) 798-7171

Baa-Baa Black Sheep–Traverse City

Traverse City's best kept secret! Euroflax, Noro, Brown Sheep, Linen, Wool, Cotton, Socks, Felting, Classes.

541 E. 8th Street (231) 947-3160

Knit Knit Knit–West Bloomfield

We are a full-service shop, carrying a spectacular line of yarns and canvasses. Orchard Mall.

6369 Orchard Lake Rd. (800) 860-KNIT

MINNESOTA

Amazing Threads–Maple Grove

Unique yarn, textile and fiber arts in NW Suburbs. Knit and crochet classes. www.amazing-threads.com

11262 86th Ave. North (763) 391-7700

Silver Creek Cabin–Maple Lake

For those on a "fiber diet", you should be able to find something to satisfy your cravings. Also unique gift items and Basketville baskets.

46 Birch Street (320) 963-4533

Creative Fibers–Minneapolis

Supplies for knitting, weaving, spinning, beading, rug hooking, fiber dyeing. bonny@creativefibers.com; www.creativefibers.com

5416 Penn Avenue S. (612) 927-8307

NEBRASKA

Personal Threads Boutique–Omaha

Everything you need for knitting, crocheting, needlepoint & weaving! Large selection of the latest and finest yarns! www.personalthreads.com

8025 W. Dodge Road (800) 306-7733

NEVADA

Gail Knits–Las Vegas

Your niche for knitting. Best stocked store for hand-knitting. 8 miles west of the Strip.

9012 W. Sahara (702) 838-7713

NEW HAMPSHIRE

Harrisville Designs Yarns and

Looms–Harrisville

Visit the most beautiful yarn shop in New England. Natural fiber yarns, supplies, books, patterns, gifts.

Main Street, Center Village (603) 827-3996

Grand View Country Store–Randolph

"A unique yarn shop". All your knitting and crocheting supplies and weekend retreats. www.grandviewcountrystore.com

89 US Route 2 (603) 466-5715

Out of State (800) 898-5715

NEW JERSEY

The Knitting Store–Cherry Hill

Unique yarns, extensive pattern selection, gift certificates, knit-ins, classes, parties, unadvertised specials and Sunday hours.

Heritage Square #14 (856) 751-7750

1871 Route 70 East

(Just past Syms, next to Bellini Baby)

Pat's Yarn Boutique–Fort Lee

Cozy little shop with variety of fine yarns and accessories for knitting and crocheting. Lessons available.

807 Abbott Blvd. (201) 224-7771

Patricia's Yarns–Hoboken

Beautiful natural fiber yarns from around the world for knitting and crochet. Lessons.

728 Washington Street (201) 217-YARN

NEW MEXICO

Miriam's Well–Santa Fe

Santa Fe's premier yarn shop. Local, national & international designer yarns. www.sfschoolofweaving.com

614 Paseo de Peralta (505) 982-6312

Needle's Eye, Inc.–Santa Fe

New Mexico's largest selection of quality yarns, books and supplies for knitting, crocheting and needlepoint.

839 Paseo De Peralta, Ste. O (800) 883-0706

NEW YORK

Stitch Therapy/A Fine Yarn Shop–Brooklyn

.....a place for the knitting, crocheting community to gather in a warm and inviting atmosphere.

176 Lincoln Pl. (Park Slope) (718) 398-2020
(Between 7th and 8th Ave)

Flying Fingers Yarn Shop–Irvington (Westchester County)

Only 40 minutes from NYC! Wide selection of unusual yarns. For classes and hours, visit www.flyingfingersyarnshop.com.

19 Main St. (914) 591-4113

Liberty Fibers–Madrid

Modern colors and textures for the traditional and urban knitter plus rug hooking and spinning supplies.

1827 RT 345 (315) 322-0437

Seaport Yarn–New York City (Wall St. area)

Wide selection of yarns, needles, patterns and gadgets at great prices. Classes available.

135 William St. 5th Fl. (800) 347-2662

Wild Wools–Rochester

Truly unique, exceptionally beautiful, earth-friendly yarns in a warm, inspiring atmosphere. "Better Yarn, Better World."

732 South Ave. (585) 271-0960

Pollywogs–Wayland

Large variety of beautiful knitting, weaving yarns, spinning fibers. Extensive line of Fiber Trends, other popular knitting patterns, books. www.mypollywogs.com

7 Bush Ave. (585) 728-5667

NORTH CAROLINA

The Tail Spinner–Richlands

Complete fiberarts center: Quality yarns, spinning wheels, looms, classes, related tools & equipment. Visit www.tail-spinner.com.

109 North Wilmington St. (910) 324-6166

OHIO

The Needling Yarn–Granville

A New Tale for Hand Knitters, Specializing in the Finest Yarns, Needles and Patterns.

130R North Prospect St. (740) 587-3877

OREGON

Woodland Woolworks–Carlton

A treasure trove of all things knitting. Located in Oregon's wine country. www.woolworks.com

100 E. Washington Street (800) 547-3725

The Knit Shop–Eugene

Full selection of yarns, needles, patterns and accessories. Visit our website! www.knit-shop.com; jean@knit-shop.com.

2821 Oak Street (541) 434-0430

Fiber Arts Northwest–Portland

Quality yarns, unique natural fibers, books, patterns, supplies, classes. Sit'n'knit with view of Mt. Hood. Easy access-affordable covered parking. Call for directions.

0315 SW Montgomery St. #340 (503) 224-3536

Lint–Portland

Your unique source for Rowan, GGH, Crystal Palace, and more.....Visit us at www.lintinc.com.

1700 NW Marshall (503) 226-8500

Knitting Bee–Portland Westside

Inspiring yarn and notions for knitting and crochet. Located 15 minutes west of Portland just off Hwy 26.

18305 NW West Union Rd (503) 439-3316

THE KNITS MARKETPLACE

YARN SHOP DIRECTORY

PENNSYLVANIA

Knitters Underground—Centre Hall

Complete knitting, weaving, spinning and needlepoint supplies. Appleton, Shetlands, Jaeger, Brittany, Schacht and much more! www.knitters-underground.com
308 S. Pennsylvania Avenue (814) 364-1433

Silverbrook Fiber Arts & Sheepskins—Marchand

10 rooms of yarn and fiber arts equipment in restored 1860 home. Punxsutawney/Indiana area. www.groundhog.net/silverbrook
16040 US Hwy Rt 119 N (724) 286-3317

Uncommon Threads—York

Novelty, traditional and luxury yarns-bags, needles and patterns. Please visit our online store at: www.uncommonthreads-pa.com
294 W. Market St. (866) 323-9276
(866) 323-YARN

RHODE ISLAND

Sakonnet Purls—Tiverton

www.letsknit.com Most complete knitting and needlepoint store in New England. Fine yarn, hand painted canvases, and more...
3988 Main Road (888) 624-9902

Bella Yarns—Warren

Join our mailing list at www.bellayarns.com and receive 10% off your next purchase!
508 Main St. (401) 247-7243

TENNESSEE

the yarn studio—Memphis

Free Shipping April thru September on website purchases! Rowan, Colinette, Trendsetter and much more! www.yarnstudio.com
816 S. Cooper Street (901) 276-5442

Yarniverse—Memphis

Yarns out of this world! We carry a fine selection of needles, yarns, and books. www.yarniverse.com
709 S. Mendenhall Rd. (901) 818-0940

TEXAS

Yarn Heaven—Arlington

3000 sq. ft. of the highest quality yarns! 7000 patterns/books. Advanced/beginner classes. www.yarnheaven.com
1300 West Arkansas Ln. (877) 280-YARN

Simpatico Yarns—Bedford

Sweet little shop near DFW Airport. Sit, chat, have coffee and plan your next project. www.simpaticoyarns.com
520 Bedford Rd. (817) 285-6067

The Woolie Ewe—Plano

Largest selection of yarn in the southwest. Email info@woolieewe.com; www.woolieewe.com
1301 Custer Rd #328 (972) 424-3163

VERMONT

The Naked Sheep—Bennington

Huge selection of yarns, knitting needles and patterns. Kits for beginning and advanced knitters. www.nakedsheep.com
423 Main St. (877) 917-4337

Vermont Beads & Fibers—Middlebury

Luscious designer yarns of all kinds and all colors! Books, tools, patterns and classes available. www.beadsandfibers.com
2 Mill St. (802) 388-6661

VIRGINIA

Blueridge Yarns at Misty Mountain Farm—Amissville

Now open with beautiful hand dyed yarns, needles, patterns, books, classes and encouragement! www.blueridgeyarns.com
154 Quail Call Lane (540) 937-4707

Aylin's Woolgatherer—Falls Church

The most complete source for knitting & crocheting artists! Specializing in needlecraft & novelty knitting yarns. www.aylins-wool.com
7245 Arlington Blvd., Ste. 318 (703) 573-1900

Holly Spring Homespun—Powhatan

A unique find for knitters, crocheters, and spinners. Unmatched selection including locally grown, hand-dyed yarn and roving. www.hollyspringhomespun.com
3837 Old Buckingham Road (804) 598-2232

WASHINGTON

Diva Yarn—Port Townsend

Everything the knitter, spinner or crocheter could want or need. Plus incredible locally made buttons, bags, yarn and silver jewelry hand cast and crafted by the shops' owner, Lois. Open daily 10-6. www.divayarn.com
940 Water Street (360) 385-4844

WISCONSIN

Artistic Fibers—Burlington

Contemporary shop offering quality yarn, patterns, accessories, and a supportive environment for your creative side.
324 N. Pine Street (262) 757-0960

The Dragonfly Yarn Shop—Janesville

Cascade, Louet, Knit One Crochet Too, Skacel, Addi Turbo, Crystal Palace, Catch the knitting spirit!
1327 N. Wright Rd. Suite 5A (608) 757-9228

CANADA

MANITOBA

Rovings—Dugald

Breed specific specialty mill/yarn shop. Multi-colored hand-dyed hand-painted Polwarth yarn—sweater, shawl, sock kits. Rovings@mb.sympatico.ca; www.rovings.com
Call for Directions (800) 266-5536

NEW BRUNSWICK

London-Wul Shop/Studio/Farm—Lakeburn

Eastern Canada's most complete specialty store for knitters/spinners/weavers. Producers of exquisite fibres & yarns. Canadas' Economuseum of Handspinning. www.thewoolworks.com
1937 Melanson Rd. (506) 382-6990

ONTARIO

Needles & Pins Inc.—London

Colour and texture galore! A destination yarn shop with a penchant for natural fibres. <http://www.needlesandpins.ca>
205 Oxford St. E. #103 (519) 642-3445

ADVERTISER'S INDEX

Acorn St. Shop	91	Knit Happens	91
Alchemy Yarns	75	Knitter's Review	107
Alpaca Fiber Exchange	114	Knitting Basket	111
American Buffalo Products	74	Knitting Central	63
Ami/Ami Canada, Inc.	70	Knitting Fever Inc.	53
Angel Hair Yarn Co.	112	Knitwex	112
Arachne Designs	83	Koigu Wool Designs	61
Artful Knitting/Precious One	113	Lady Peddler	115
As Soon As I Finish This Row	103	Lakeside Fibers	110
Ashland Sky	110	LaLana Wools	82
Aurora Yarns	83	Lambpun of Colorado	32
Aylin's Woolgatherer	94	Lampen, Betty	114
Berocco	111	Lanaknits	114
Blue Sky Alpacas	61	Lion Brand Yarn Co.	11c
Bluster Bay Woodworks	113	Lorna's Laces	63
Bovidae Farm	114	Louet Sales	39
Brittany Company	67	Mannings, The	102
Brookman Imports/Plassard Yarns 42		Marr: Haven	114
Brown Sheep Company	21	Mid Atlantic Fiber Assn.	103
Buxton Brook Looms	111	Misti International Alpaca	94
Carodan Farm Wool Shop	115	Montat Publishing	57, 83
Carolina Homespun	75	Morehouse Design	50
Cascade Yarns	62	Mountain Colors Yarns	107
Cat Bordnii	87	Muench Yarns	15
Cherry Tree Hill Yarn	102	Nancy's Knit Knacks	113
Chris Bylsma Designs	94	Needlepoint Joint, The	87
Classic Elite Yarns	1bc	Nomad Press	114
Coats & Clark, Inc.	35	Northeast Fiber Arts Center	107
Colonial Needle	103	Oat Couture	103
Color Me Yarn	34	Oberle, Cheryl	111
Colorful Stitches	62	One Fine Yarn	114
Common Threads	114	Organized Knitter, The	110
Cotton Clouds	91	Ott-Lite Technology	31
Crafts Americana	1bc	Pagosa Fiber Festival	113
Creative Strands	94	Paradise Fibers	114
Dale of Norway	17	Perfect Buttons	113
Dancing Leaf Farm	115	Plymouth Yarn Co.	5
Denise Interchangeable Knitting		Prairie Fibers Co., The	90
Needles	71	Purl	25
Earth Guild	111	Rosie's Yarn Celler	112
Elann.com Inc.	55	Sawyer Brook Distinctive Fabric	113
Elegant Ewe, The	110	Seaport Yarn	90
Exquisitely Angora	110	Shuttles, Spindles & Skeins	94
Fairfield Processing Corp.	27	Skacel Collection, Inc.	71, 87, 113
Fiber Studio, The	112	South West Trading Company	63
Fiber Trends	46	Stitch DC	90
Fiddlesticks Knitting	87	Stitch Diva Studios	102
Fiesta Yarns	71	String	112
Genesee Valley Handspinners		Susan's Fiber Shop	110
Guild	103	T & C Imports	82
Genuine Purl	111	Tahki Stacy Charles/NY Yarn	3
Glory-ous Knits	111	Taos Sunflower	111
Goddess Yarns	57	The Couture Knitting Workshop	113
Goose Pond	113	The Yarn Lounge	61
Great Yarns	61	Three Black Sheep, A Yarn Shop	115
Green Mountain Spinnery	110	TNC Enterprises	91
Habu Textiles	115	Tradewind Knitwear Designs	114
Halcyon Yarn	66	Tree of Life Designs	90
Hand Jive Knits	91	Two Swans Yarns	103
Handworksgallery.com	32	Unique Colours	43
Harrisville Designs	67	Valley Yarns	67
Henry's Attic, Inc.	34	Weaving Works	111
Henschlers	63	Web*sters	75
Himalaya Yarn	112	Webbs	32
Hip Chics Knit	110	Westminster Fibers	10, 51, 52
Hug Me Company	113	White Lies Designs	71
In The Bag Handknits	113	WildFiber	38
INKnitters	107	Wool Connection	83
Interweave Press	86, 107, 108, 112	Wool Gatherer's LLC	115
JCA Inc.	47	XRX Stitches	56
Jo Sharp PTY LTD	54	Yarn Barn	57
Joseph Galler, Inc.	75	Yarn Barn, The	115
Judi & Co.	107	Yarn Lady	67
K1C2	70	Yarn Tree, The	115
Knit and Stitch=Bliss	94	Yarns By Design	91

Knitting a Life Together

Lory Widmer Hess



When my husband asked me to show him how to knit, I was delighted. Not just because we could spend cozy hours together on the couch with our knitting projects, though the idea was certainly appealing. No, what really excited me was the possibility that now he would be able to knit himself something tailored to his very particular requirements and thus free me from this responsibility.

Don't get me wrong—Michael is a very sweet man. He couldn't be more accommodating when it comes to housework, cooking, or car repair. But if we're talking about something he has to wear, on his back, he gets a little, well, er, fussy. He wants a garment that he wouldn't be ashamed to wear on the streets of Milan or Paris. When I think sweater, I see a bulky, oversized swath of comfort knitting. When he thinks sweater, he sees a fine-gauge creation with fancy lapels and leather trim. I've never been sure that I was up to this kind of challenge.

But I didn't mind getting him started on doing it himself. In fact, I was quite curious to see what he would come up with. We visited the yarn shop and happily rummaged through an abundance of options. Mohair, lopi, or merino? Solid-color or variegated? Smooth or textured? Every possibility had to be considered at length. Finally, Michael settled on three colors of an elegant silk-cashmere yarn. Now, what to knit with it? A scarf, the typical beginner's project? No, too boring—and he doesn't like scarves anyway. He decided to adapt a wraparound poncho I had once made, scaling it down for a more tailored fit around his shoulders.

Not long afterward, Michael was off and knitting. Recalling my own early efforts, when I clung to a pattern as if to a life raft,

I was impressed by his inventiveness. He devised his own stitch pattern of knit-purl stripes. He came up with a short-row cast-off method to shape the neckline, though I hadn't shown him either technique. When the fit turned out to be too baggy, he boldly cut a piece out of the back and knotted the loose yarn ends to create a mitered, fringed seam. He picked up stitches for a turtleneck and again figured out how to use short rows to shape the back of the neck. In terms of design—and daring—he was way beyond me.

He still needed me to help him decipher the strange holes and loops that mysteriously and unnervingly appear in any beginner's knitting. I explained about dropped, slipped, and twisted stitches, and occasionally knitted a few rows when he became frustrated with his slow pace. The project grew between us. I contributed a certain degree of experience and understanding of knitted fabric; he brought creativity uninhibited by knowledge.

When I said, "I don't think you can do that," He said, "Why not?" and did. Even if it didn't work, the attempt taught us something new. I was reminded of our different cooking styles. I like to follow a recipe in order to learn a new technique, slowly evolving variations as I gain confidence. He, on the other hand, consults only the contents of the refrigerator and his own taste buds, with results that are often brilliant and occasionally questionable. Sometimes he needs to be more grounded; sometimes I need to be less methodical. By balancing each other, though, we make a good team, one that knits together two polarities.

And in the long run, knitting is like marriage in that it involves the cooperation of opposites. The needles, hard,

straight, and finite in length, must interact with the fluid, soft, and infinitely extendable yarn. The yarn needs the rigidity of the needles in order to be shaped into a definite pattern. The needles need the malleable substance of the yarn in order to create something new, not fixed in past forms. Alone, yarn and needles have little potential; together, they can create a fabric of almost any texture, any shape imaginable. Knitted fabric can be at once soft, strong, warm, protective, and flexible—not unlike a good relationship. Thinking about the relationship of needles to yarn, I am reminded of my resolve to appreciate the ways in which my partner and I are different; to remember that our individual gifts often reveal themselves only when they're challenged by the other's abilities.

As Michael and I knit our lives together into the future we'll be turning dreams into reality, just as a pattern in the mind's eye becomes manifest on the needles. I know the outcome won't always be what we expect or hope for. The miniponcho, after all, never quite measured up to Michael's exacting standards—he's already talking about his next project, in which he "won't make so many mistakes." But when I look at his first effort, uneven and blotchy though it is, I smile. I know we'll make mistakes in our life together, but it's still well worth the attempt to create something entirely new—and wonderful—between us.

LORY WIDMER HESS lives with her husband in Chestnut Ridge, New York, where they are still trying to decide what to do with all the yarn they bought on their honeymoon.

Direct from Italy: Knit a Pair of Socks for \$7.38!



Traveling the World to Bring You
Affordable Knitting!

Kelley Petkun in Florence, Italy 2005



Sweet Tarts
23554



Snapdragon
23549



Autumn
23551



Storm
23548



Vineyard
23547



Sunset
23552



Tropics
23550



Crayons
23553

Introducing Simple Stripes!

75% Superwash Wool, 25% Nylon self-striping, fingering-weight yarn

See our entire collection of yarns at
www.knitpicks.com/socks
or call 1-800-574-1323 for a FREE catalog.
We also offer a wide selection of tools as
well as books at up to 30% savings.

Knit Picks

Only \$3.69
for each 50 gram ball. 231 yards.

Use the promo code "Socks"
for **FREE shipping**
on your Simple Stripes order.

Offer expires 07/31/05



Classic Elite Yarns



Bubbles

Spring 2005 Handknitting brings new fibers, bright fresh colors, vintage cables and fit.

Bubbles, cotton/nylon, has bright cheerful colors, fabulous texture, and is fun to knit.

Four Seasons, cotton/wool, is an all-season yarn available in tweed-look prints and solid colors.

Bam Boo, 100% bamboo fiber is environmentally friendly, a renewable resource, has a silky hand and incredible colors.

Patterns for **Bubbles** are found in our Spring '05 booklet, **Country Road**.

Four Seasons patterns found in **Joyride**.

Bam Boo patterns in **Farm**.

All Classic Elite yarns available only at America's finest yarn shops.



Four Seasons



Bam Boo

Visit our website, www.classiceliteyarns.com, for photographs of all garments in all of our Booklets, all yarns in all colors, and to find a retailer in your area. To order any of these booklets, send a large SASE and \$12.95 each to:

Classic Elite Yarns, Dept ISU05, 122 Western Avenue, Lowell, MA 01851